

## VZ 2.0: The Next Generation Garden Bed Material

VZ 2.0 is a specially developed metal by Vego Garden for the unique planting environment with high level of compost, fertilizer, and humidity. VZ 2.0 is made with patent Zinc Alloy coating on top of steel substrate, finished with food safe agriculture paint to further seal the metal.

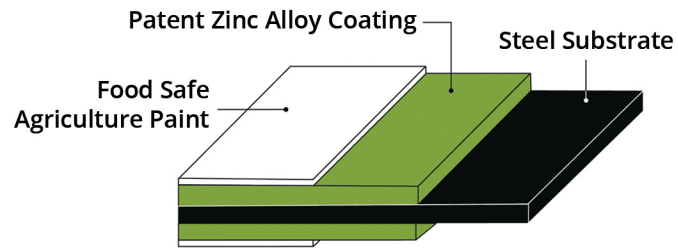

- Extremely Corrosion Resistant: Lab tests proved 4-6 times more durable than Aluzinc or Galvanized Steel.
- Super Heat Reflection: Maintain optimal soil temperature.
- Healthy Soil: No harmful substance leaching.
- 100% Green Material: Recyclable material manufactured by green-process.

## Dimensions

Diameter: 42"

Height: 17"

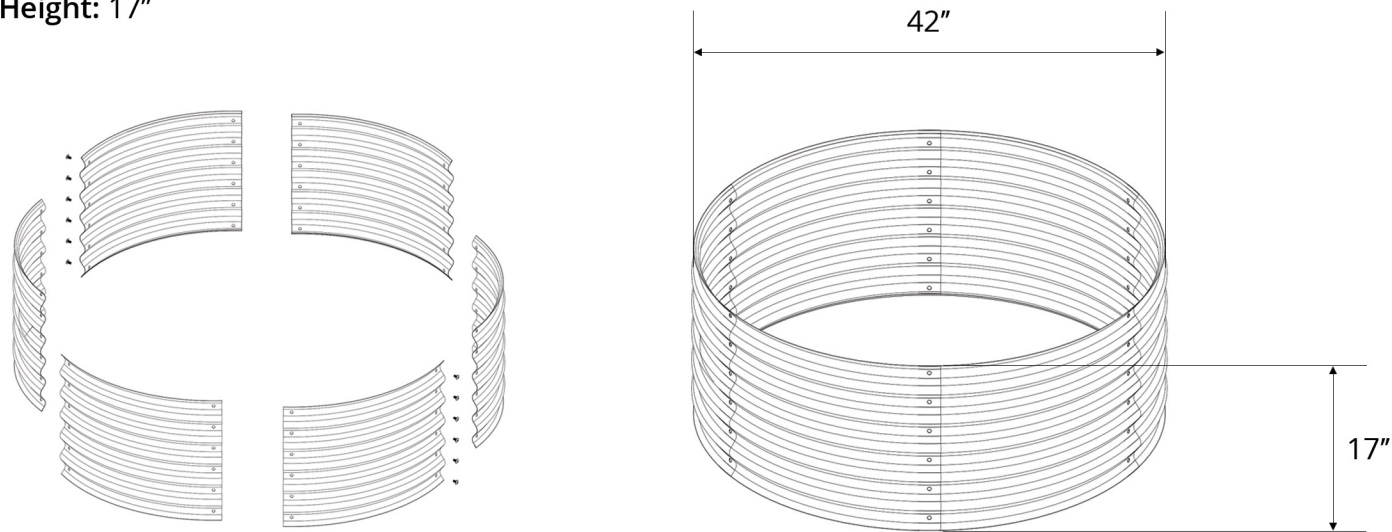

## Contact Us

- +1 (628) 220-8868
- hello@vegogarden.com
- www.vegogarden.com
- Houston, TX 77023



vegō garden





# ROUND METAL RAISED BED



### Caution

Please be aware that there are sharp edges in metal panels that may cause injury. The use of protective equipment such as gloves and closed toe shoes is recommended.

# Packing List

- A: Curved Panel  X6
- B: Cap Nut Fastener Set  X12
- C: Standard Fatener Set  X24
- D: Safety Rubber Edging  X1

# Assembly Guide

**1 Step One**

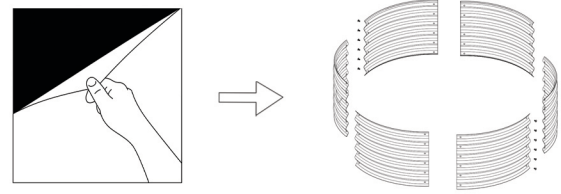

Remove protective films from all panels, and lay panels on a flat surface according to the above configuration.

**2 Step Two**

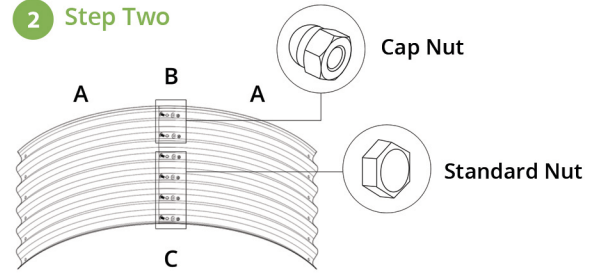

Cap nuts are used for top two rows, standard nuts are used for lower 4 rows. Assemble all curved panels: initially attach all bolts, washers and nuts loosely, and then tighten up using the wrench tool (as supplied) with a screwdriver/cordless drill.

**3 Step Three**

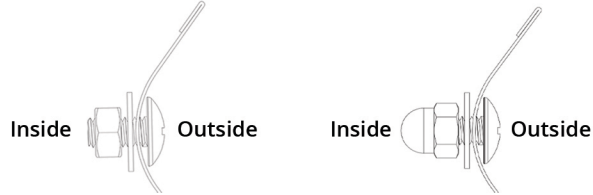

Make sure to tighten each nut and bolt for reinforcement of garden raised bed.

**4 Step Four**



Push the safety rubber edging to the top rolled steel edge and cut the extra length off. Make sure edging is attached securely.

**5 Step Five**

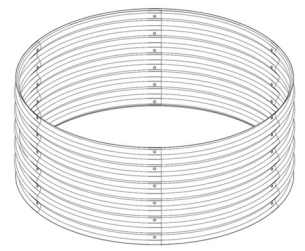

Congratulations on completing the assembly! Now you can start to build your dream garden!

**✓ Enjoy**



# Follow Us On Social Media

 @vegogarden  
  @vego\_garden  
  #vegogarden / #raisedbedgardening / #metalgardenbed

