

# FLEXSTAR<sup>®</sup> 645W LED USER MANUAL

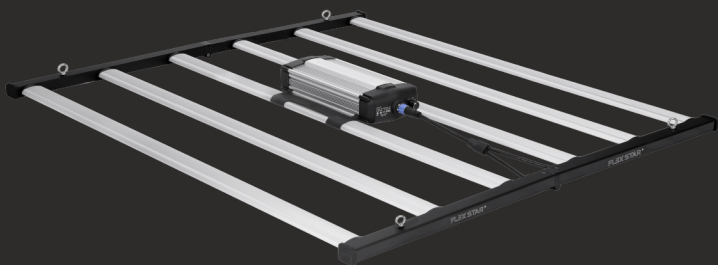

SAMSUNG  
HORTICULTURE LED



Illuminated

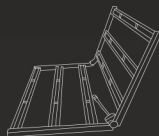
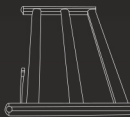

# FLEXSTAR® 645W LED

## USER MANUAL

### 1. INTRODUCTION

Thank you for purchasing the FLEXSTAR® 645W LED grow light. Our manual will describe the installation and mounting of the product as well as a description of how to use it. Please have an experienced, certified service personnel mount and install this device. Please read and understand this manual in its entirety before using the product. Only use this product as specified within the manual.

### 2. PRODUCT DESCRIPTION

The FLEXSTAR® 645W is an electronic horticultural LED fixture with six LED light bars to be used in greenhouses or in climate-controlled rooms.

In this manual, we will refer to the FLEXSTAR® 645W LED as “the LED fixture.”

### 3. PRODUCT INFORMATION AND SPECIFICATIONS

#### 3.1 TECHNICAL SPECIFICATIONS

##### FLEXSTAR® 645W LED

Spectrum

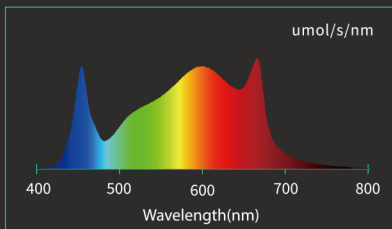

Light Source	Samsung 3030 & OSRAM 3535
Spectrum	Full spectrum
PPF	1800 $\mu\text{mol/s}$
Efficacy	2.8 $\mu\text{mol/J}$
Input Voltage	120V 208V 240V 277V
Input Current	5.38A 3.10A 2.69A 2.33A
Frequency	50/60 Hz
Input Power	645W
Fixture Dimensions	47.6" L x 43.6" W x 4.1" H 121cm x 110.8cm x 10.5cm
Weight	36.4lbs / 16.5kg
Temperature Ambient	95°F / 35°C
Mounting Height	$\geq 6"$ Above Canopy
Thermal Management	Passive
External Control Signal	RJ connector
Dimming Option	40% / 50% / 60% / 80% / 100%
Light Distribution	120°
Lifetime	L90: >54,000hrs
Power Factor	>90%
Waterproof Rate	IP66
Warranty	5-year warranty

# FLEXSTAR 645W LED USER MANUAL

## 3.2 ENVIRONMENT

This product is intended to be used in greenhouses and climate-controlled rooms and can be used in damp environments. However, please DO NOT use this product outdoors or in wet environments and do not expose it to water. The LED fixture works at optimal capacity when the ambient air temperature is between 68 ~ 95°F / 20 ~ 35°C.

## 4. SAFETY RECOMMENDATIONS AND WARNINGS

**Warning!** Please read the following instructions carefully before using or working with the product!

- Always adhere to local rules and regulations when installing or using the LED fixture.
- Do not open or disassemble the LED fixture, it contains no serviceable parts inside. Opening or modifying the LED fixture can be dangerous and will void the warranty.
- This product may cause interference to radio equipment and should not be installed near maritime safety communications equipment or other critical navigation or communication equipment operating between 0.45 - 30 MHz.
- Do not use the LED fixture when either the LED fixture or its power cord are damaged. Replace the power cord only with original certified cords.
- Modifications to the cords can lead to unwanted electromagnetic interference and effects and will void the warranty and nullify any compliance with legal regulations.
- Do not expose the LED fixture to:
  - Condensation, humidity, heavy mist, fog, or direct spray;
  - (Ambient) temperatures outside the specified range;
  - Dust and/or contamination;
  - Direct sunlight during use or HID light that could heat up the power supply enclosure.
- Always disconnect the LED fixture from mains before performing any maintenance.
- Always allow for a cool down period of at least 30 minutes before touching the LED bars. Touching the LED bars when the fixture is lit or immediately afterwards will result in severe burns!
- Do not use the LED fixture near flammable, explosive or reactive substances. The LED fixture reaches temperatures of >104° F / 40° C.
- Do not use sulfur vaporizers or water misters.
- The installation and the use of this LED fixture are the responsibility of the end user. Incorrect use or installation can lead to malfunction and failure of the LED device. Any damage to the LED fixture and electronic security as a result of incorrect installation and use revokes the warranty.

# FLEXSTAR® 645W LED USER MANUAL

## 5. CONTENTS

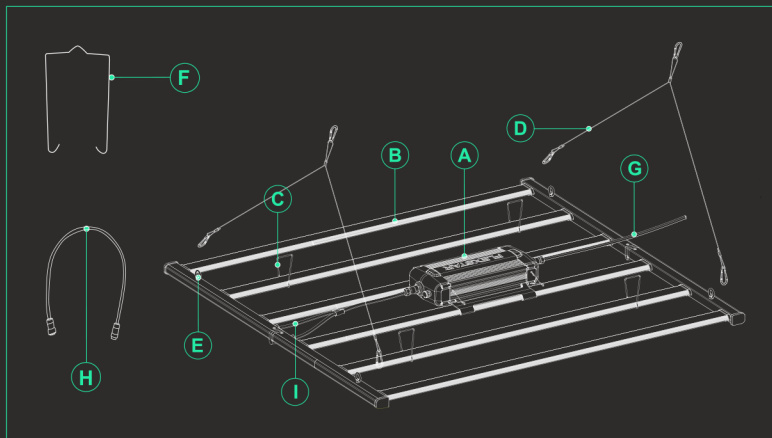

- Ⓐ LED Drivers
- Ⓑ LED Bars
- Ⓒ Solid Decking Mount
- Ⓓ Lance Hanger
- Ⓔ Ring Screw
- Ⓕ Waterfall Mount
- Ⓖ Input Power Cord
- Ⓗ Extension Cord
- Ⓖ Interconnect Cable
- Ⓙ Instruction Manual

## 6. INSTALLATION

**Warning!** Warning! Mounting and installing of the LED fixture may only be executed by certified service personnel, in accordance with the applicable local laws and regulations.

**Warning!** The installer is responsible for correct and safe installation.

**Warning!** Ensure the local cabling can support the voltage and current requirements of the LED fixture.

**Warning!** Avoid coiled cords and keep mains leads separated. This prevents electromagnetic interference.

**Warning!** Do not connect or disconnect the LED fixture under load.

# FLEXSTAR® 645W LED USER MANUAL

## 6.1 INSTALLATION PREPARATIONS

We will ship the LED fixtures with your choice of hanging hardware. In order to mount your LED fixture properly, start by identifying a suitable support structure you can mount your fixture on. Common support structures include pallet racks, trusses, structural channels, Unistrut, and rolling tables. For optimal results, we recommend that two people mount this fixture together.

**Warning!** Be sure to mount the system to something that can hold the weight of the LED fixture.

**Note:** Take caution if you touch the LED bars. Ensure the LED array does not come in contact with sharp objects or force that may damage the diodes and be sure to wait at least 30 minutes for the LED strips to cool down before touching the LED strips with your hand as they will be hot!

## 6.2 MOUNTING WITH SOLID DECKING MOUNTS

What's Included: Solid decking mounts.

We suggest hanging the LED fixture from cross bars in a rack system that has solid support guaranteed not to collapse under weight.

To create proper balance, be sure to position the LED fixture parallel to the length of the rack while you're setting up.

- Using the solid decking mounts, loop each mount across the crossbar above the LED light bar second from the end of either side of the fixture. Use two decking mounts on either end.

**Note:** Do not attach mounting hardware to the end light bars. You risk damaging the fixture if you do.

- Once all four decking mounts are in place, use two people to lift up the LED fixture and mount it on the decking mounts. You can do this by delicately prying apart the hooks until there is enough room to slide the fixture between. Release the decking mounts and they will hook around the fixture.

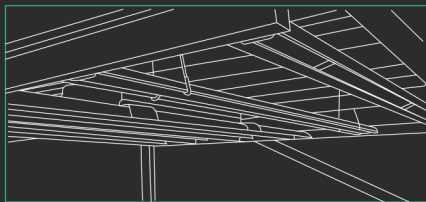

# FLEXSTAR® 645W LED USER MANUAL

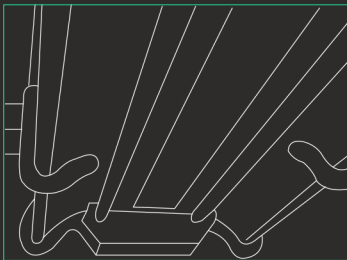

- Adjust the LED fixture so that each decking mount makes as much surface contact with the fixture as possible.
- Now that the fixture is secured to the decking mounts, you can adjust the position of the lights by sliding the decking mounts across the crossbars and settle it in the appropriate location for your growing operation.  
Note: It is possible to hang the LED ballast separately. Please refer to paragraph 6.4

- If you plan to use the LED fixture as a standalone, continue to paragraph 6.6.  
If you plan to use a Master Controller, continue to paragraph 6.5.  
If you plan to install other LED fixtures, simply repeat the steps from paragraph 6.1 and 6.2.

## 6.3 MOUNTING WITH LANCE HANGERS

We suggest that you hang the LED fixture from two points in an area with high clearance, such as ceilings or other support structures. We've included 2 lance hangers for this job.

Before you mount your LED fixture, please complete the following steps to attach the power supply to the light bars, as outlined in 6.4.

**Note:** The power supply enclosure **MUST** be mounted on the center two light bars before hanging with the lance hangers.

- Find the four ring screws and slide the lance hanger into two of the ring screws. Gently pull the hanger up from the center of the hanger until the loop snaps into place.
- Once both hangers are securely in place, use two people to lift the fixture to install the hanging hardware. Be sure to hang from the center of the lance hanger otherwise you may have an unbalanced fixture.

# FLEXSTAR® 645W LED USER MANUAL

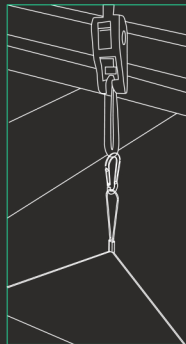
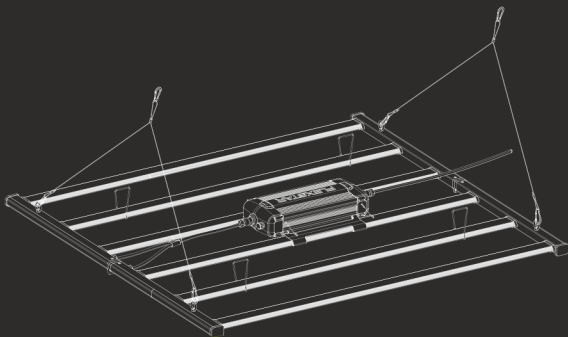

- If you use the LED fixture as a standalone, continue at paragraph 6.6. If you do use a Master Controller, continue at paragraph 6.5
- To install other LED fixtures, repeat the steps at paragraph 6.1 and 6.3.

## 6.4 MOUNTING THE POWER SUPPLY ENCLOSURE

- When unboxing and unfolding the LED fixture for the first time, place it on a flush, level surface with the LEDs facing down.
- There are three ways to mount your power supply: attach to the light bars, remote mount to a surface or hang up with the waterfall mounts.

(1) First, open the brackets on the power supply box. Attach the brackets to the center two bars of the LED fixture. Connect the M19 male adaptor on the LED fixture to the M19 female outlet on the power supply enclosure. Connect the M19 male connector on the LED fixture to the M19 female connector on the power supply enclosure.

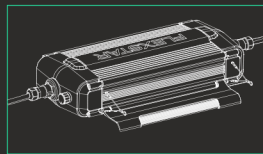

# FLEXSTAR 645W LED USER MANUAL

(2) Identify the lock receivers on the underside of the power supply enclosure. Attach the locking receiver to the nail on the wall. Connect the M19 male adaptor on the LED fixture to the M19 female outlet on the extension cord, then connect the extension cord's the M19 male connector to the appropriate female outlet on the power supply.

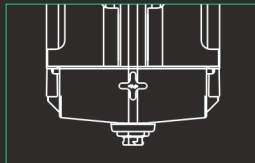

(3) Loop the waterfall mounts on the wire deck or cross bar. Slightly separate the mounting hardware until the hooks slide into the holes on the side of the power supply enclosure.

As mentioned in the previous steps, simply connect the male end of the LED fixture to the extension cord, then attach the extension cord to the power supply enclosure.

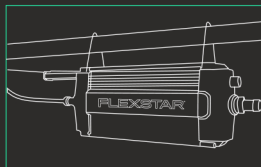

## 6.5 CONNECTING UP TO 160 LED FIXTURES

- Remove the dummy from the input port on the first LED fixture.

**Note: Keep the dummy in a safe place!** The dummy is necessary to operate the LED fixture in standalone mode.

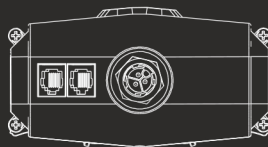

- Set the knob to EXT.

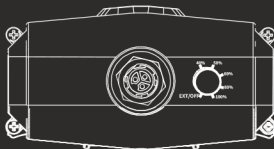



# FLEXSTAR® 645W LED USER MANUAL

- We have included a black controller cable along with the controller to connect the controller to the input port on the first LED fixture, for your convenience.
- Remove the dummy from the input port on the second LED fixture.
- Use a black 6p4c modular jack interconnect cable with an integrated ferrite core to connect the output of the first LED fixture with the input of the second LED fixture.
- Repeat these steps and you can connect up to 160 LED fixtures.

Warning! Ensure the power cord and the controller cables do not touch any of the LED bars. Otherwise you risk electric shock!

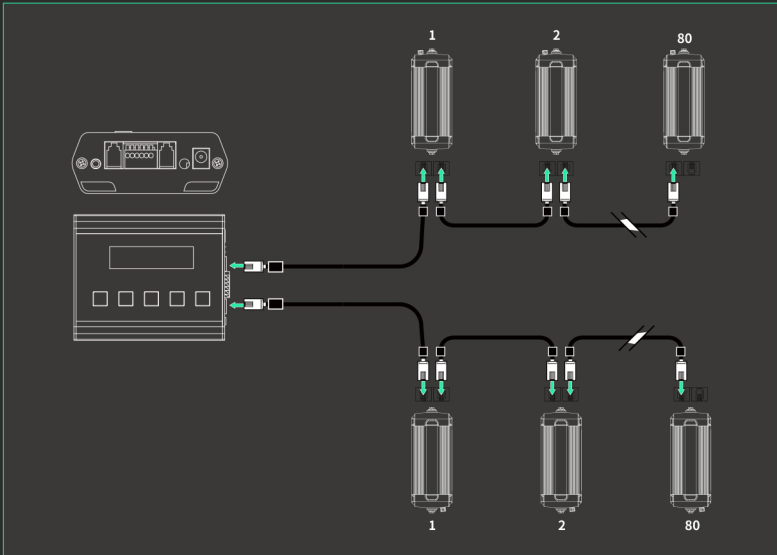

# FLEXSTAR® 645W LED

## USER MANUAL

### 6.6 CONNECTING THE LED FIXTURE TO THE MAINS

**Warning!** Make sure mains power is switched off before connecting the light fixture.

**Caution!** Ensure the cord is not coiled and does not touch any hot surfaces.

**Warning!** Connect the cables according to local rules, safety regulations and electrical code.

**Warning!** Ensure the external switching gear can cope with the inrush of electric current of the LED fixture (reference paragraph 3.1 for further details). Always use a double pole contactor that is suitable for switching a capacitive load.

- Connect the M19 female connector on power cable to the male connector on the power supply enclosure.
- Connect the power cable to the mains.
- Switch on mains power

**Warning!** Do not connect or disconnect the LED fixture under load.

### 7. PRECAUTIONS WHEN USING THE LED FIXTURE

**Warning!** Always wait 20 - 30 minutes for the LED bars to cool down!

### 8. INSPECTION, MAINTENANCE AND REPAIR

**Warning!** Disconnect the LED fixture from mains before performing any maintenance or repairs.

**Warning!** Do not connect or disconnect the LED fixture while it is under load.

**Warning!** Do not open or disassemble the LED fixture, it contains no serviceable parts inside. Opening the LED fixture can be dangerous and will void the warranty.

**Warning!** Always allow for a cool down period of at least 30 minutes before touching the LED bars.

**Caution!** Do not clean the LED fixture with detergents, abrasives or other aggressive substances.

- Please regularly check the LED fixture for dust or dirt buildup. Clean if necessary. Contamination may cause overheating and decreased performance. Clean the outside of the LED fixture using a dry or damp cloth.
- Regularly check the cables of the LED fixture to ensure it is undamaged.

### 9. STORAGE AND DISPOSAL

- Store the LED fixture in a dry and clean environment, with an ambient temperature of  $-4 \sim 185^{\circ} \text{F}$  /  $-20 \sim 85^{\circ} \text{C}$ .
- The product must not be discarded as unsorted municipal waste, but must be collected separately for the purpose of treatment, recovery and environmentally sound disposal.

# FLEXSTAR® 645W LED USER MANUAL

## 10. WARRANTY

The company warrants the mechanical and electronic components of this product and guarantees the materials and workmanship free of defects if used under normal operating conditions, for a period of five (5) years from the original date of the purchase.

If you find that there are any defects with this product that relate to either the workmanship or the materials but are not due to improper use or user error, the company shall, at its discretion, either replace or repair the product using the appropriate new or reconditioned parts. In the case that the company decides to replace the entire product, the date of the limited warranty shall apply to the replacement from the date of the purchase of the initial product for five (5) years.

FLEXSTAR® 645W LED



# FLEXSTAR® 645W LED USER MANUAL

## FLEXSTAR® 645W LED

