

Rev	Date
A	17 / 05 / 2023

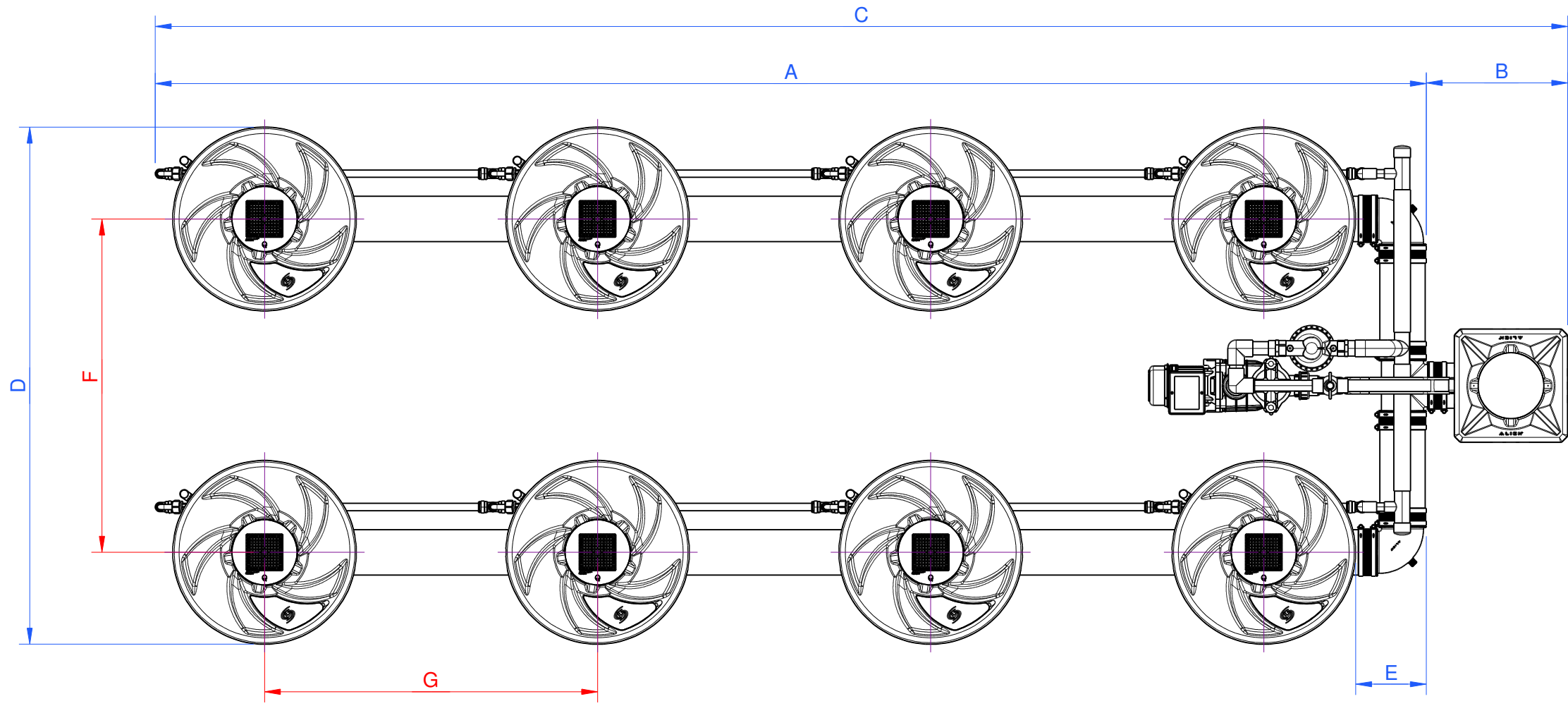

Inverted Header:

The header can be located inside the footprint as shown.

This option reduces overall length of system to dimension "A" (please refer to dimensions table).

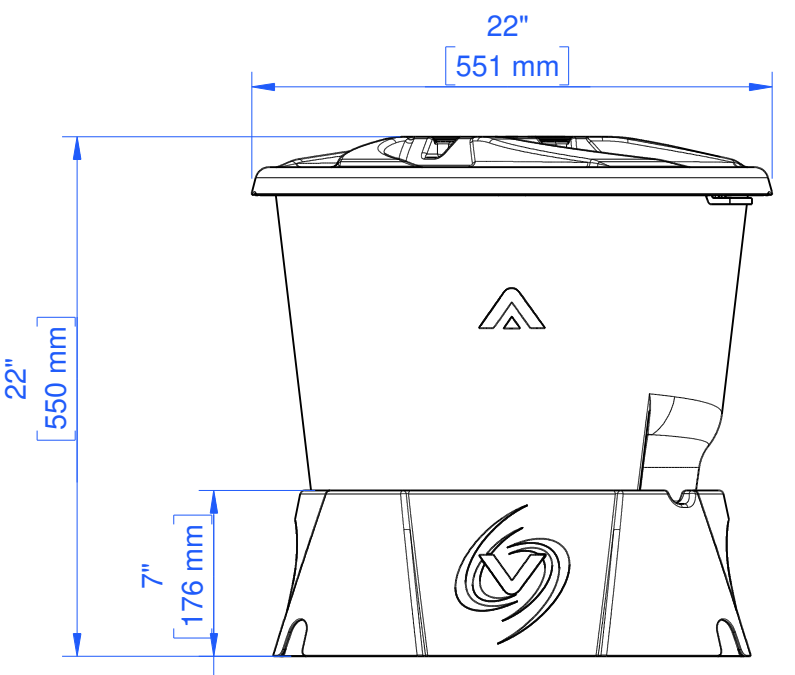
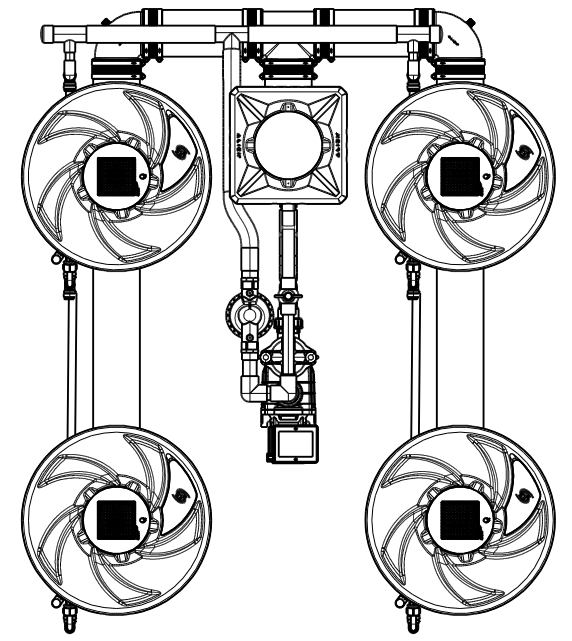

Dimensions	Minimum	Maximum @ 40" / 1m Plant Centers*
A	100" (2530mm)	150" (3820mm)
B	17" (420mm)	42" (1070mm)
C	116" (2950mm)	193" (4890mm)
D	48" (1200mm)	61" (1550mm)
E	8" (210mm)	8" (210mm)
F	26" (650mm)	40" (1000mm)
G	23" (580mm)	40" (1000mm)

*** Note:**
Plant centers greater than 40" / 1m are possible with custom order lengths of 5" tubing, please contact sales@alienhydro.com for more details.



Project: V-SYSTEM	Scale 1 : 16
Title: 2 Row 8 Pot	
Drawing Number: V-2.8_US	Sheet 1 of 1