

Rev	Date
A	17 / 05 / 2023

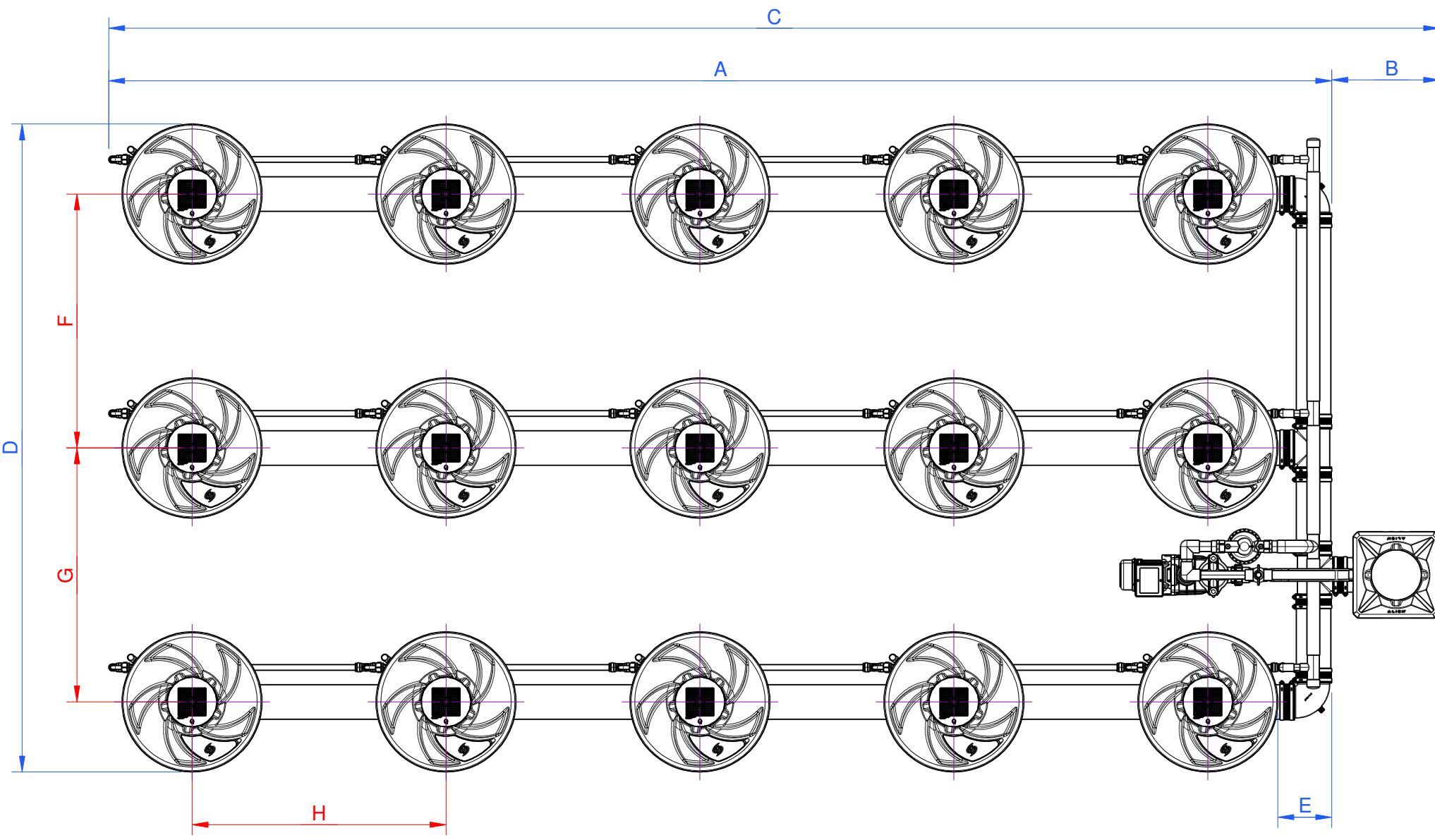

Inverted Header:

The header can be located inside the footprint as shown.

This option reduces overall length of system to dimension "A" (please refer to dimensions table).

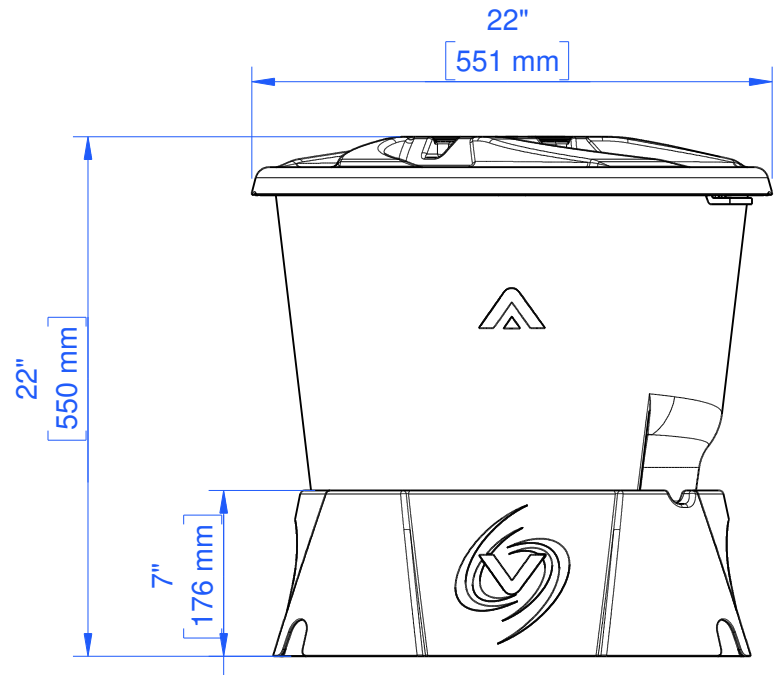
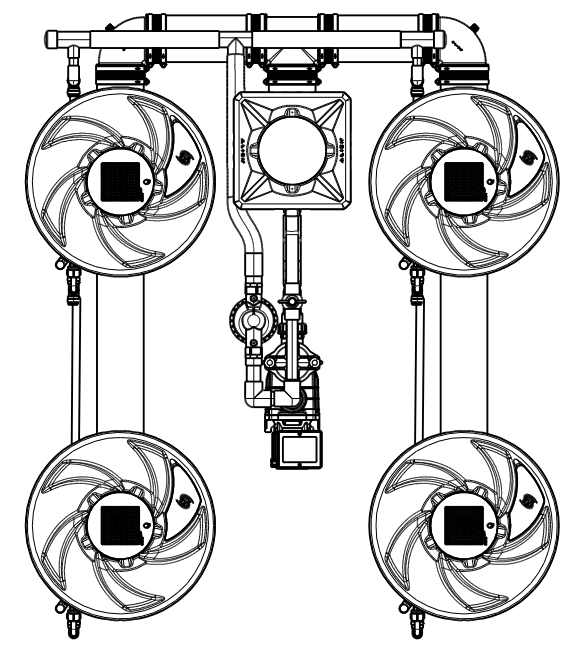

Dimensions	Minimum	Maximum @ 40" / 1m Plant Centers*
A	122" (3110mm)	190" (4820mm)
B	17" (420mm)	42" (1070mm)
C	139" (3530mm)	232" (5890mm)
D	69" (1760mm)	100" (2550mm)
E	8" (210mm)	8" (210mm)
F	22" (560mm)	40" (1000mm)
G	26" (650mm)	40" (1000mm)
H	23" (580mm)	40" (1000mm)

*** Note:**
Plant centers greater than 40" / 1m are possible with custom order lengths of 5" tubing, please contact sales@alienhydro.com for more details.

	Project: V-SYSTEM	Scale 1 : 21
	Title: 3 Row 15 Pot	
	Drawing Number: V-3.15_US	Sheet 1 of 1