

Quest 150 Dual

Installation, Operation and Maintenance Instructions

– Read and Save These Instructions –

This manual is provided to acquaint you with the dehumidifier so that installation, operation and maintenance can proceed successfully. Ultimate satisfaction depends on the quality of installation and a thorough understanding of this equipment. The dehumidifier is built around tested engineering principles and has passed a thorough inspection for quality of workmanship and function.

Providing 150 pints of water removal per day at standard rating conditions (80°F/60%RH), the Quest 150 Dual will effectively control humidity while using only 11.0 amps/115V.

Features:

- High capacity
- High efficiency
- Environmentally friendly
- Patent pending dual-air distribution

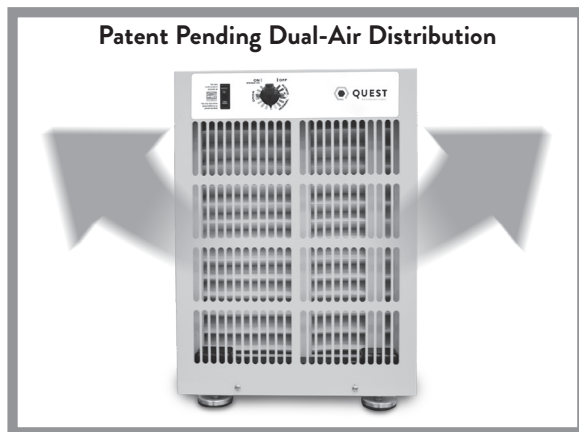

Water Removal Rates (Pints/Day)

150 pints 80°F, 60% (AHAM)



4201 Lien Rd
Madison, WI 53704
www.QuestClimate.com

Phone 608-237-8400
Toll-Free 1-877-420-1330
info@QuestClimate.com

Table of Contents

Safety Precautions 3

1. Intended Application(s)..... 4

2. Registration 4

3. Specifications 4

4. Installation 5

 4.1 Remove Compressor Shipping Support 5

 4.2 Location 5

 4.2A How to hang dehumidifier 5

 4.3 Electrical Requirements..... 6

 4.4 Install Leveling Feet 6

 4.5 Condensate Water Removal..... 7

5. Ducting 8

 5.1 Outlet Duct Kit 8

6. Operation 8

 6.1 Humidity Control Adjustment 8

 6.2 Fan Switch 8

7. Maintenance 8

 7.1 Air Filter 9

8. Service 9

 8.1 Technical description 9

 8.2 Troubleshooting..... 10

9. Service Parts List 12

10. Accessory/Replacement Parts List 12

11. Wiring Diagram 13

Warranty 14



Safety Precautions

Read the installation, operation and maintenance instructions carefully before installing and operating this device. Proper adherence to these instructions is essential to obtain maximum benefit from your Quest **150 Dual** indoor air quality system.

READ AND SAVE THESE INSTRUCTIONS

- The device is designed to be installed **INDOORS IN A SPACE THAT IS PROTECTED FROM RAIN AND FLOODING.**
- Install the unit with space to access the back or side panels for maintenance and service. **DO NOT INSTALL UNIT WITH THE SERVICE PANELS INACCESSIBLE.**
- Avoid directing the discharge air at people, or over the water in pool areas.
- If used near a pool or spa; be certain there is **NO** chance the unit could fall into the water, be splashed and that it is plugged into a **GFI GROUND FAULT INTERRUPT OUTLET.**
- **DO NOT use the device as a bench or table.**
- **DO NOT** place the device directly on structural members. Provide vibration isolation in order to minimize operational vibration and/or noise.
- A drain pan **MUST** be placed under the unit if installed above a living area or above an area where water leakage could cause damage
- If the supply cord is damaged, it must be replaced by the manufacturer, its service agent or similarly qualified person in order to avoid a hazard.

1. Intended Application for Quest 150 Dual

The Quest 150 Dual is intended for use in light commercial structures: however, the unit can be placed in almost any setting where dehumidification is desired. Use in highly corrosive applications and pool areas may void warranty.

The Quest 150 Dual works most effectively between 56° and 95°.

In order to efficiently control humidity levels, the area in which the dehumidifier is to be operated must be free of water intrusion or excessive fresh (outside) air infiltration. Before installing the Quest 150 Dual, water intrusion and air infiltration problems should be addressed.

2. Registrations

The Quest 150 Dual units conforms to unified standard UL 60335-2-40 and CSA standard C22.2.60335-2-40.

3. Specifications

4034230 Quest 150 Dual	
Blower:	430 CFM @ 0.0" WG
Power:	1300 Watts @ 80°F and 60% RH
Supply voltage:	115 VAC - 1 Phase - 60 Hz.
Current Draw:	11.0 Amps
Energy Factor:	2.29 L/kWh
Operating Temp:	56°F Min - 95°F Max
Minimum Performance @ 80°F and 60% RH:	
Water Removal:	150 Pints/Day
Efficiency:	4.8 Pints/kWh
Air Filter:	MERV-8 Size: 14" x 17.5" x 2"
Power Cord:	10', 110-120 VAC, Ground
Drain Connection:	3/4" Threaded NPT or 5/8" Hose Barb
Dimensions:	Unit Shipping
Width:	14.5" 19"
Height:	21" 27"
Length:	26" 35"
Weight:	95 lbs 100 lbs

4. Installation

⚠ CAUTION! Remove compressor shipping tie from the unit. Failure to remove shipping tie will cause excess vibration to be transmitted to the frame.

4.1 Remove Compressor Shipping Support

The Quest 150 Dual uses a compressor to power the refrigeration system. To protect the compressor and refrigeration system during shipping a plastic tie wrap secures it to the units frame. Remove the tie wrap by cutting the tie wrap and pulling from the unit as shown. After removing tie wrap, insert plastic plugs provided into the holes.



4.2 Location

The Quest 150 Dual can be installed in a variety of locations to meet the owner’s needs; other considerations include:

1. Providing access to a 115 VAC power outlet (10’ power cord is provided).
2. Locating near a floor or other suitable drain.
3. Mount at least 4” above drain. (P-trap recommended - See pg. 8)
4. Do not install the Quest 110 Dual with the exhaust of the unit within 1’ of a wall or obstruction. Do not place the unit near open water.
5. Duct work not recommended for gardening (DO NOT duct heat out).
6. Hanging not required - Floor install is ok.

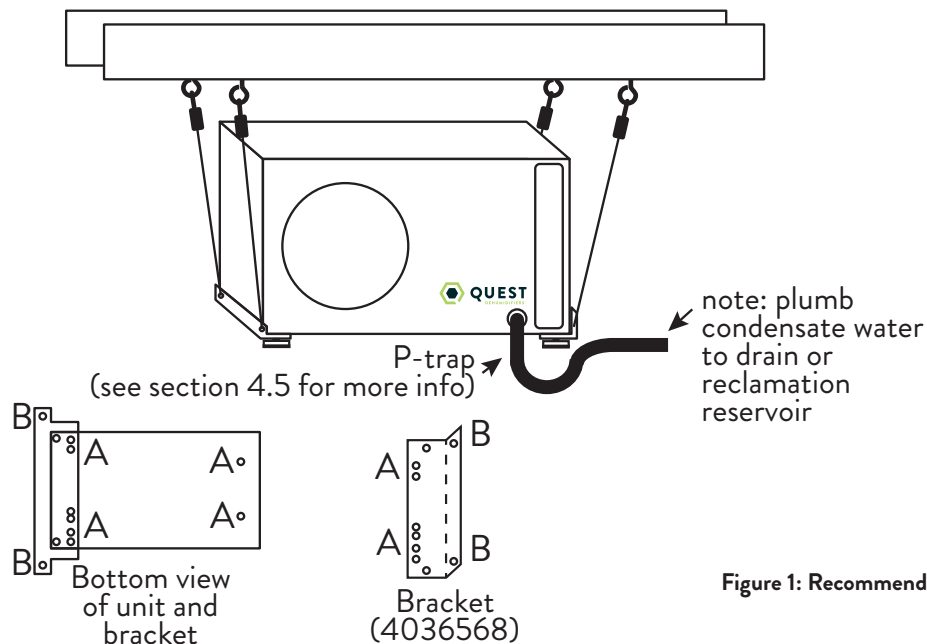

Figure 1: Recommended install shown

4.2A How to hang dehumidifier

- A. Attach brackets (PN 4036568) with feet. Tighten with 5/8” wrench.
- B. Attach chain or SunGrip to bracket. Ensure materials have adequate weight rating.

4.3 Electrical Requirements

The Quest 150 Dual plugs into a common grounded outlet on a 110-120 VAC 15-Amp circuit. While operating, it draws 11.0 amps @ 80°F, 60% RH and 10 amps @ 75°F, 50% RH. Use of a ground fault circuit interrupter (GFCI) protected circuit is recommended. The unit should not be used in areas prone to flooding.

⚠ CAUTION! For proper drainage, the unit must be mounted so the drain outlet is at least 4” above the floor drain, and must be fully supported under the base.

4.4 Installing Feet

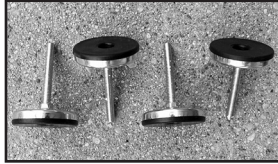

Included with your Quest 150 Dual are four leveling feet. It is important to level the unit for proper draining.

Figure 1: Four leveling feet.

Installing Leveling Feet

See Figure 2 for installing leveling feet.

1. Lay down a protective pad (pillow, blanket, etc.).
2. Carefully turn unit onto side opposite drain port.

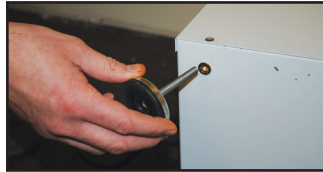

Figure 2: Insert leveling feet in locations.

3. Align leveling foot shaft with one of the four threaded hole locations as shown in Figure 2.
4. Screw each leveling foot in ten revolutions.
5. Carefully bring unit to upright position.
6. Level unit for proper water drainage.
7. Wait 10 minutes before operating.

⚠ CAUTION! Note: Operating the unit immediately after bringing it to an upright position can possibly damage the compressor. A short amount of time is needed (10 minutes) to allow the oil to return to it's reservoir for lubrication.

4.5 Condensate Water Removal

The Quest 150 Dual drains via gravity, therefore, it does not have the ability to push condensate (water) uphill. The drain hose must run downhill toward the drain location. Condensate can be drained by using the 5/8” clear vinyl hose and the 3/4” threaded adapter provided. Ensure the threaded adapter is threaded in tightly.

⚠ CAUTION! The Quest 150 Dual drains via gravity, therefore, it does not have the ability to push condensate (water) upwards. The drain hose must run down towards the drain location. Condensate can be drained by using the 5/8” clear vinyl hose and the 3/4” threaded adapter provided. Ensure the threaded adapter is threaded in tightly.

⚠ CAUTION! The Quest 150 Dual requires a drain trap. Creating a drain trap allows a small amount of water to build up in the trap area of the clear hose. This prevents air from back flowing through the hose and into the dehumidifier; essentially causing the unit to backflow water out of the corners of the machine. Position the trap in the hose approximately 8”-10” from the dehumidifier and make sure the highest point of the trap is still at least 2” below the black drain port adapter on the dehumidifier. If the highest point of the trap is above the drain port, water will back flow into the dehumidifier. Check the hose regularly to ensure water is draining properly.

Several trap options include:

Use care to keep the hose as flat to the floor as possible after your trap is in place. Be sure the hose is not kinked or otherwise restricted so water can pass through the hose freely. Improper installation of the drain hose may result in water leakage.

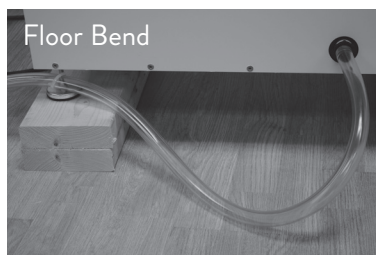
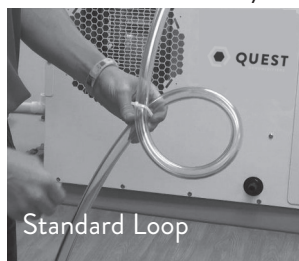

PVC materials available from your local hardware store.

If the Quest 150 Dual is located too far from the floor drain and the provided hose does not reach, you may use a 1/2” PVC rigid pipe to extend the drain. Rigid PVC tubing is readily available from your local hardware store. Be sure the extension is at a down-ward slope to the drain.

An optional condensate pump kit may be installed if lift is required to remove condensate. To order, contact your local dealer or visit our website at www.QuestHydro.com. You may also reach us by phone at (800) 533-7533.

5. Ducting
5.1 Duct Kit

Factory designed duct kits can be purchased to accept 10” ducting to all outlets of the Quest 150 Dual. Contact your dealer or order online.

6. Operation
6.1 Humidity Control Adjustment

The humidity control is an adjustable switch that closes when the relative humidity of the air in which it is located rises to the dial set point. It opens when the RH drops 4 to 6% below the set point.

Approximate Humidity Levels Per Setting:

- “Drier” 20% to 30% Relative Humidity
- “Normal” 45% to 55% Relative Humidity
 (Recommended)
- “Humid” 80% to 90% Relative Humidity

FAN ON
 Fan runs all the time to circulate air.

FAN AUTO
 Fan only runs when dehumidifier is on. (recommended).

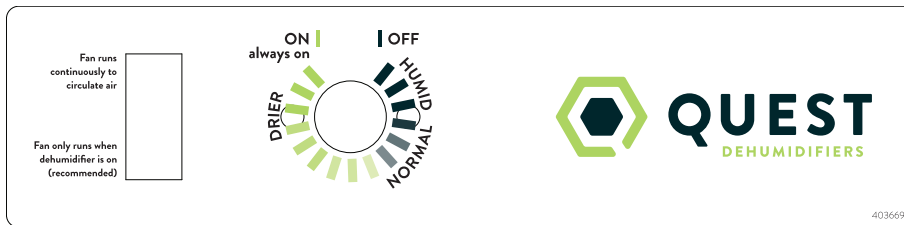

The dehumidifier will run until the relative humidity (RH) is reduced to the humidity control dial setting.

Quality humidity meters are available from the factory and are recommended to accurately monitor humidity levels. Refer to the options and accessories table in this document.

6.2 Fan Switch

Turning the impeller switch to “**FAN ON**” will cause the unit’s internal impeller to run continuously, whether the unit is dehumidifying or not. This function is desirable if the unit is used for air circulation.

Turning the fan switch to “**FAN AUTO**” will cause the unit’s internal blower to run only while the unit is dehumidifying.

7. Maintenance

⚠ CAUTION! NOTE: Do not operate the unit without the filter or with a less effective filter. The heat exchange coils inside the unit could become clogged and require disassembly to clean.

7.1 Air Filter

The Quest 150 Dual ships with a standard MERV 8 pleated fabric filter. This should be checked every six months. The pleated fabric filter can generally be vacuumed clean several times before needing replacement. Operating the unit with a dirty filter will reduce dehumidifier capacity and efficiency and may cause the compressor to cycle on and off unnecessarily. Replacement filters can be ordered from your dealer or by calling 1-800-533-7533.

8. Service

⚠ WARNING! Servicing the Quest 150 Dual with its high pressure refrigerant system and high voltage circuitry presents a health hazard which could result in death, serious bodily injury, and/or property damage. Only qualified service people should service this unit.

⚠ CAUTION: If the supply cord is damaged, it must be replaced by the manufacturer, its service agent or similarly qualified person in order to avoid a hazard.

8.1 Technical Description

The Quest 150 Dual uses a refrigeration system similar to an air conditioner’s to remove heat and moisture from incoming air, and add heat to the air that is discharged. Hot, high pressure refrigerant gas is routed from the compressor to the condenser coil. The refrigerant is cooled and condensed by giving up its heat to the air that is about to be discharged from the unit. The refrigerant liquid then passes through a filter/drier and capillary tubing which cause the refrigerant pressure and temperature to drop. It next enters the evaporator coil where it absorbs heat from the incoming air and evaporates.

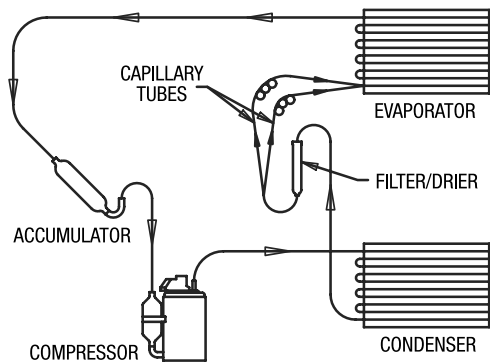

Quest 150 Dual refrigeration system

8.2 Troubleshooting

FOR THE USER:

If the unit does not work properly, please check the following:

- Is the unit unplugged?
- Is power to outlet on? (check switch, if applicable)
- Is circuit breaker tripped?
- Is humidity control set? (turn to “ON”)
- Is air flow restricted? (check air filters and grill)

If none of the above, call dealer or 1-800-533-7533.

FOR THE HVAC PROFESSIONAL:

No dehumidification. Neither blower, nor compressor run with fan switch AUTO.

1. Unit unplugged or no power to outlet, circuit breaker tripped.
2. Humidity control set to “Humid” setting.
3. Loose connection in internal wiring.
4. Humidity control is defective.

No dehumidification. Compressor does not run but blower runs with fan switch AUTO and humidity control turned to ON.

1. Defrost thermostat open, ambient temperature too low.
2. Loose connection in compressor circuit.
3. Defective compressor overload.
4. Defective compressor or compressor run capacitor.

Blower runs with fan switch AUTO but compressor cycles on & off.

1. Low ambient temperature and/or humidity causing unit to cycle through defrost mode.
2. Defrost thermostat defective.
3. Defective compressor overload.
4. Defective compressor.

Blower does not run with fan switch in either position. Compressor runs briefly but cycles on and off.

1. Loose connection in blower circuit.
2. Obstruction prevents impeller rotation.
3. Defective blower.
4. Defective blower switch.

Evaporator coil frosted continuously, low dehumidifying capacity.

1. Dirty air filter or air flow restricted.
2. Defrost thermostat loose or defective.
3. Low refrigerant charge.

If none of the above has fixed the issue, call technical support at 1-800-533-7533.

9. Service Parts List

Call your dealer or 1-800-533-7533.

Part No	Description
4033859-02	Evaporator
4032702	Capillary Tubes
4030131	Compressor
1970010	Compressor Relay
4029510	Filter/drier
4034099	Condenser
4035463	Impeller
4033032-06	50mfd 370V Capacitor - Compressor
4035235-10	12mfd 370V Capacitor - Impeller
4026221	Leveling Foot
4031376	Defrost Thermostat
4027172	Humidity Controller
4025560	Fan Switch
4036568	Bracket

Accessory/Replacement Parts

Call your dealer or 1-800-533-7533.

Part No	Description
4031062	Filter MERV 8
4038127	Filters 4-Pack, MERV 8
4038125	Filters 12-Pack, MERV 8
4022220	Pump Kit
4033039	Duct Kit, Supply
4039697	Duct Kit, Return

11. Wiring Diagram

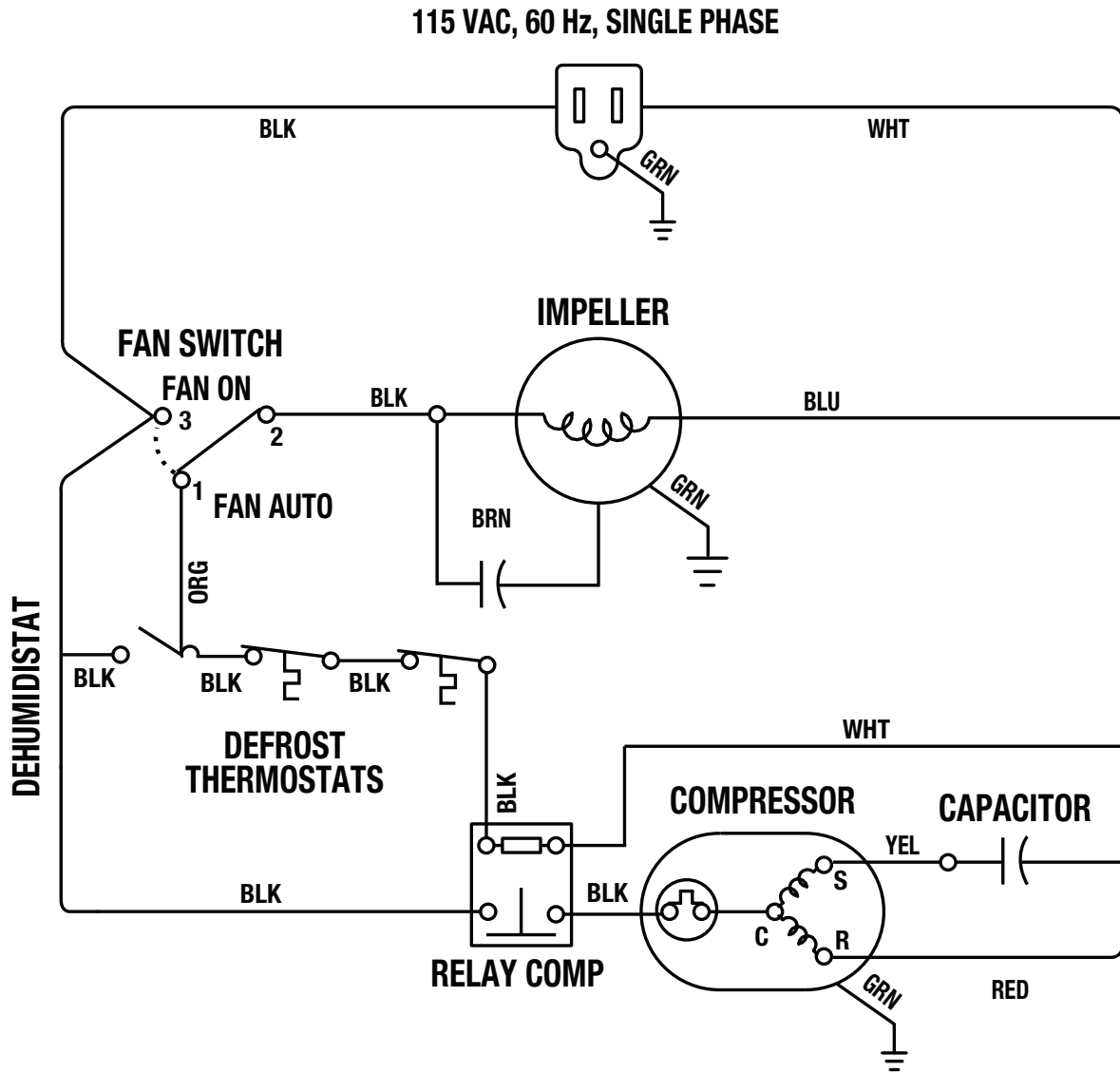

Quest 150 Dual Dehumidifier Limited Warranty

WARRANTOR:

Therma-Stor LLC
4201 Lien Rd
Madison, WI 53704
Telephone: 1-800-533-7533

WHO IS COVERED: This warranty extends only to the original end-user of the Quest 150 Dual dehumidifier, and may not be assigned or transferred.

FIRST YEAR WARRANTY: Therma-Stor LLC warrants that, for one (1) year the Quest 150 Dual dehumidifier will operate free from any defects in materials and workmanship, or Therma-Stor LLC will, at its option, repair or replace the defective part(s), free of any charge.

SECOND THROUGH FIFTH YEAR WARRANTY: Therma-Stor LLC further warrants that for a period of five (5) years, the condenser, evaporator, and compressor of the Quest 150 Dual dehumidifier will operate free of any defects in material or workmanship, or Therma-Stor LLC, at its option, will repair or replace the defective part(s), provided that all labor and transportation charges for the part(s) shall be borne by the end-user.

END-USER RESPONSIBILITIES: Warranty service must be performed by a Servicer authorized by Therma-Stor LLC. If the end-user is unable to locate or obtain warranty service from an authorized Servicer, he should call Therma-Stor LLC at the above number and ask for the Therma-Stor LLC Service Department, which will then arrange for covered warranty service. Warranty service will be performed during normal working hours.

The End-user must present proof of purchase (lease) upon request, by use of the warranty card or other reasonable and reliable means. The end-user is responsible for normal care. This warranty does not cover any defect, malfunction, etc. resulting from misuse, abuse, lack of normal care, corrosion, freezing, tampering, modification, unauthorized or improper repair or installation, accident, acts of nature or any other cause beyond Therma-Stor LLC's reasonable control.

LIMITATIONS AND EXCLUSIONS: If any Quest 150 Dual Dehumidifier part is repaired or replaced, the new part shall be warranted for only the remainder of the original warranty period applicable thereto (but all warranty periods will be extended by the period of time, if any, that the Quest 150 Dual Dehumidifier is out of service while awaiting covered warranty service).

UPON THE EXPIRATION OF THE WRITTEN WARRANTY APPLICABLE TO THE Quest 150 Dual DEHUMIDIFIER OR ANY PART THEREOF, ALL OTHER WARRANTIES IMPLIED BY LAW, INCLUDING MERCHANTABILITY AND FITNESS FOR A PARTICULAR PURPOSE, SHALL ALSO EXPIRE. ALL WARRANTIES MADE BY THERMA-STOR LLC ARE SET FORTH HEREIN, AND NO CLAIM MAY BE MADE AGAINST THERMA-STOR LLC BASED ON ANY ORAL WARRANTY. IN NO EVENT SHALL THERMA-STOR LLC, IN CONNECTION WITH THE SALE, INSTALLATION, USE, REPAIR OR REPLACEMENT OF ANY Quest 150 Dual DEHUMIDIFIER OR PART THEREOF BE LIABLE UNDER ANY LEGAL THEORY FOR ANY SPECIAL, INDIRECT OR CONSEQUENTIAL DAMAGES INCLUDING WITHOUT LIMITATION WATER DAMAGE (THE END-USER SHOULD TAKE PRECAUTIONS AGAINST SAME), LOST PROFITS, DELAY, OR LOSS OF USE OR DAMAGE TO ANY REAL OR PERSONAL PROPERTY.

Some states do not allow limitations on how long an implied warranty lasts, and some do not allow the exclusion or limitation of incidental or consequential damages, so one or both of these limitation may not apply to you.

LEGAL RIGHTS: This warranty gives you specific legal rights, and you may also have other rights which vary from state to state.