

Table of Contents

Introduction	3
Equipment	3
General Guidelines	4
Daisy-Chaining	4
Installation Overview	5
Permanent Installation Instructions	6
Temporary/Test Installation Instructions	8

Introduction

This manual provides installation instructions for the Boost and Infinity 2.0 LED light bars for under canopy lighting. Instructions are provided for large scale permanent installations as well as temporary test/trial installations. Please contact customer support with any questions not covered in this guide.

Equipment - Permanent Installation

Required Equipment

- LED Light Bars, Thrive Agritech part number BST-130W-FS2 (recommended) or TBAR-65W-FS2
- Slide & Lock Clips, Thrive Agritech part number SLCLIP, Quantity 2 for each light bar
- Interconnection Clips, Thrive Agritech part number INCLIP-BD, Quantity 1 for each light bar
- Power Cables, Thrive Agritech, several lengths and connector options to choose from
- 1.5" x ¼in.-20 bolts & matching nuts, 2 sets for each light bar
- Adjustable trellis mounting structure with steel or aluminum square tubing
 - Recommended supplier: Innovative Growers Equipment (<https://www.innovativegrowersequipment.com/plant-support-system-trellis>)
 - Alternate source of square tubing: Unistrut (<https://www.unistrut.us/products/telestrut-system/telestrut-products>)

Equipment - Temporary Test Installation

Required Equipment

- LED Light Bars, Thrive Agritech part number BST-130W-FS2 (recommended) or TBAR-65W-FS2
- Power Cables (Thrive Agritech), several lengths and connector options to choose from
- Interconnection Clips, Thrive Agritech part number INCLIP-BD, Quantity 1 for each light bar
- Structure to support the light bars
 - Recommended support: 4"-8" container pot

Optional Equipment

- Unistrut square tubing (<https://www.unistrut.us/products/telestrut-system/telestrut-products>)
- Slide & Lock Clips (Thrive Agritech)
- ¼"-20 bolts & matching nuts, 2 sets for each light bar

General Guidelines

- Confirm the overall integrity of the light bar prior to installation.
- Maintain at least 8 inches (0.2 meters) between the light fixture and any combustible materials.
- Keep the light fixture away from sources of heat.
- The LED light is an indoor fixture operated within an ambient temperature range of -20°C to 30°C.
- Ensure power is off before installation. Installation must be carried out by qualified electricians.
- To clean the light fixture, switch power off and use a dry cloth without corrosive cleaning agents.

Daisy-Chaining

The maximum number of lights that can be daisy-chained together at various input voltages is shown in the tables below. Also shown is the nominal current supplied to each fixture. 16AWG wire is recommended.

Boost LED Light

Parameter	120 Volts	240 Volts	277 Volts
Nominal current / fixture	1.1A	0.55A	0.48A
Max # of fixtures linked together in a daisy-chain	7 fixtures	12 fixtures	16 fixtures

Infinity 2.0 LED Light

Parameter	120 Volts	240 Volts	277 Volts
Nominal current / fixture	0.54A	0.27A	0.23A
Max # of fixtures linked together in a daisy-chain	10 fixtures	20 fixtures	30 fixtures

Installation Overview

An overview of the installation concept is shown in the figure below.

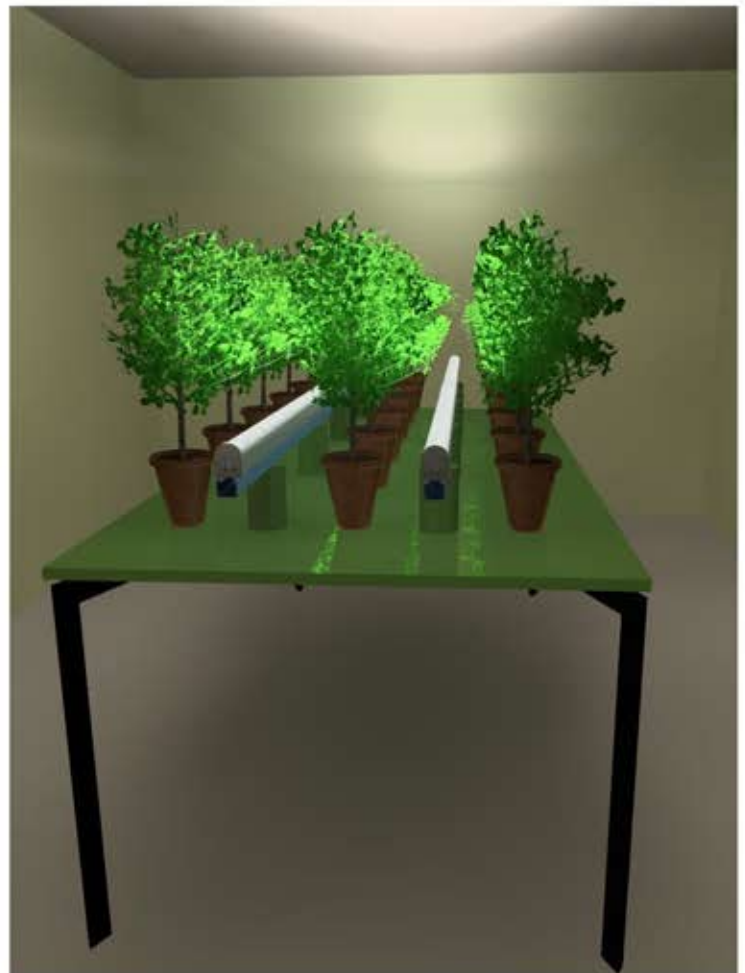
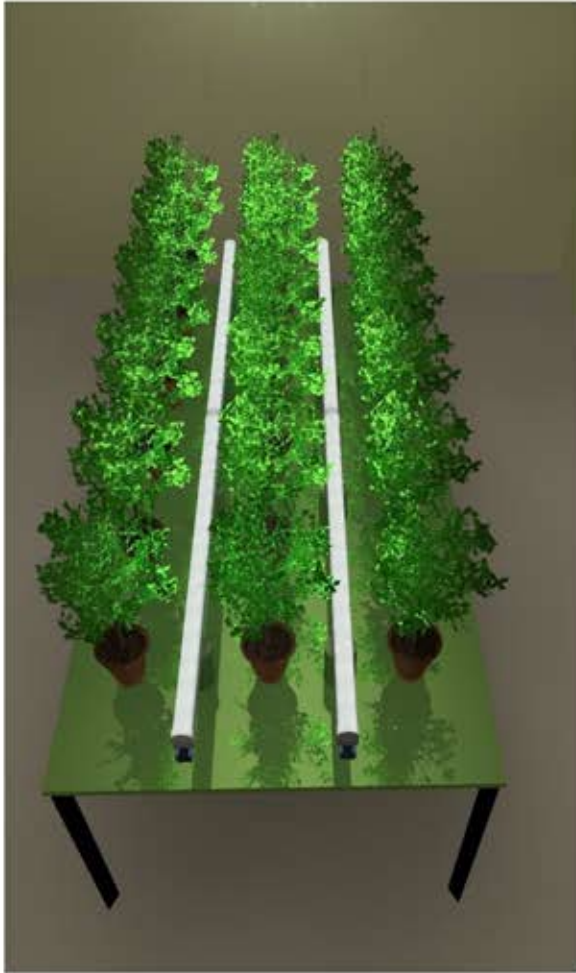

Permanent Installation Instructions

- 1) Prepare the adjustable trellis support structure as shown in Figure 1. Adjust the square tubing to the desired height. The lights will be mounted to the square tubing in subsequent steps.

Figure 1

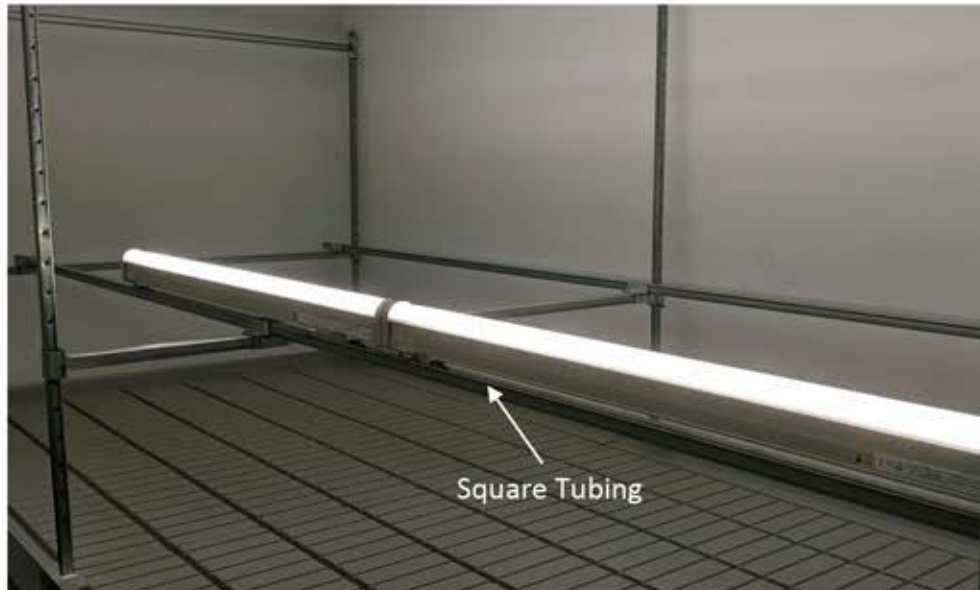

Figure 2

- 2) For each light bar, attach 2 slide & lock clips (SLCLIP) to the square tubing using $\frac{1}{4}$ "-20 bolts (Figure 2). A hole may need to be drilled through the square tubing for the bolt. The clips should be positioned approximately 6"-8" from where the ends of the light bars will be located.
- 3) Attach the light bars to the main center clips shown in figure 2 but leave the locking arms disengaged to allow the lights to slide and connect with each other (Figure 3).

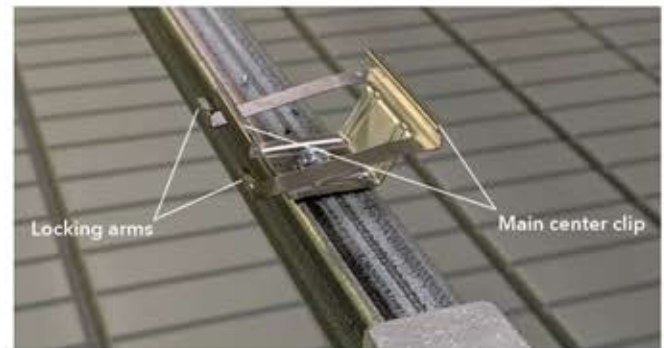

Figure 3



- 4) Once the lights are connected, attach the interconnection clip (INCLIP-BD) as shown in Figure 4 to secure the lights mechanically and electrically.



- 5) Compress the locking arms of the slide & lock clips (SLCLIP) to prevent the lights from moving along the length of the square tubing (Figure 5).

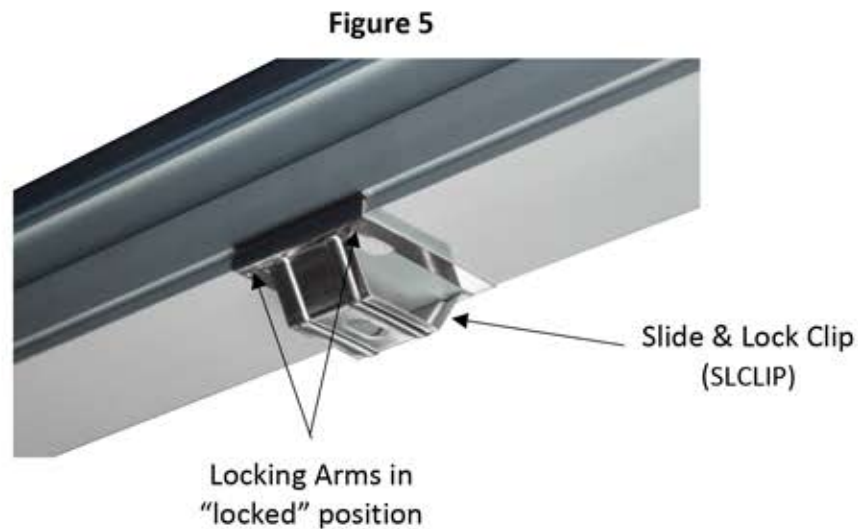

- 6) Repeat steps 1-5 for all under canopy lights in the grow room. Note the maximum number of lights that can be connected (daisy-chained) is shown on page 4 of this guide and on the light bar product datasheet.
- 7) Connect power cables to lights.

Temporary/Test Installation Instructions

For a temporary setup of under canopy lighting for the purpose of testing / trials, a simpler and faster installation method is often preferred.

- 1) Place a container pot every 4-feet along the length of the test bench where the connection points of the lights are anticipated (Figures 6 & 7).

Figure 6

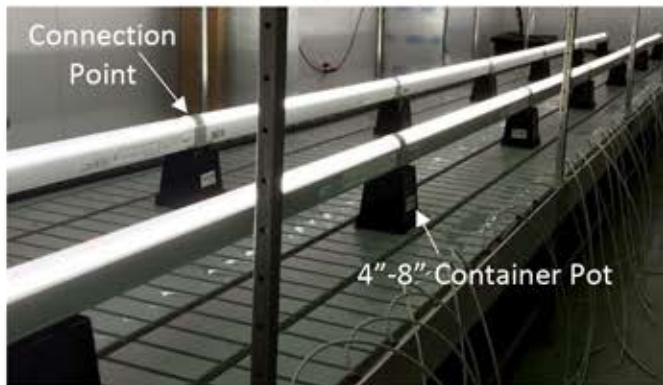
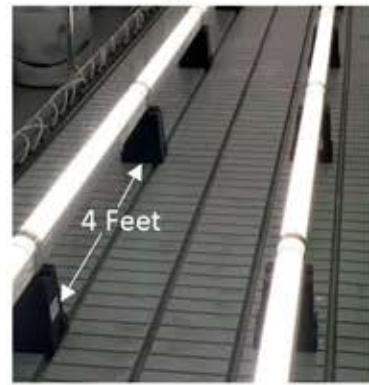

Figure 7



- 2) Connect two light bars together using the interconnection clip (INCLIP-BD) as shown in Figure 8 to secure the lights mechanically and electrically. Place connected light bar assembly on top of the container pots with the connection point (interconnection clip) resting on the container pots.

Figure 8



- 3) Repeat steps 1 & 2 for the entire test bench or test grow room.
- 4) Connect power cables to lights.
- 5) Optional: For a more robust and flexible test setup, use the installation method described in the prior section for a permanent installation.