



**iLW**  
LED Lighting Solutions



# USER MANUAL

**iLW 40W IL-4025FSG-120**

**iLW 60W IL-6025FSG-120**

**iLW 80W IL-8025FSG-120**



1-877-540-5588  
iluminarlighting.com  
sales@iluminarlighting.com



# CONTENTS

Pre-Install Information .....	2
Technical & Physical Specifications.....	3
Hardware & Accessories .....	4
Hanging Instructions .....	5
Mounting Instructions .....	7
Important Cautions & Warranty .....	8

## Please read this manual thoroughly prior to installing or operating the ILUMINAR iLW.

- Observe all safety precautions (see page 8), seek the services of a qualified electrician, installation professional, or call ILUMINAR Lighting technicians for assistance.
- DO NOT handle or touch the fixture while in use.
- Connect the fixture only to the power sources of the appropriate voltage using the correct AC plug type. Protect power cables from being pinched, walked on, or otherwise damaged. Be especially careful where the power cable enters the power outlet to the unit. Only connect the fixture to an electrical outlet or extension cord of comparable standard and level rating. Connect the fixture ONLY to the power sources of the correct voltage using the plug received.
- The fixture should only be cleaned as directed. Always seek service for your system by qualified service personnel if any of the following occur:
  - The fixture shows a noticeable change in performance.
  - The power-supply cord or plug is damaged.
  - The fixture has been dropped, or the exterior is damaged.



# iLW

40W / 60W / 80W MODELS

TECHNICAL SPECS	40W	60W	80W
PPF	100 $\mu\text{mol/s}$	150 $\mu\text{mol/s}$	200 $\mu\text{mol/s}$
Input Current	0.55	0.83	1.1
Output Power	36.3	54.6	72.6
BTU	136	204	272
Emitter Type	Multiple Spectrum LED Diodes		
Efficacy	2.5 $\mu\text{mol/J}$		
Input Voltage	Smart Sensing™ 100V - 277V		
Finishing Height	6-12" to top of Canopy		
Emitter Cooling	Passive / Extruded Case		
Waterproof Rating	IP65 for Damp/Wet Conditions		
LED Lifespan (90%)	55,000+ hours		
Power Factor	> 90%		
Ambient Temperature	-20..+45°C		
Max. Temperature	75°C/167°F		
Color Temperature	4000k		
Relative Humidity	98%		
Main Frequency	50 / 60Hz		
THD	< 20%		
Color Rendering Index	88		
Min. Power Factor	0.9		
Crest Factor	0.99		

### VOLTAGE AND AMPERAGE

	40W		60W		80W	
120V	0.36A	42W	0.53A	62W	0.69A	82W
208V	0.20A	41W	0.30A	61W	0.40A	81W
240V	0.18A	40W	0.27A	60W	0.36A	80W
277V	0.16A	41W	0.24A	61W	0.31A	81W

### PHYSICAL SPECS

	40W	60W	80W
Height	29mm / 1.14"	29mm / 1.14"	29mm / 1.14"
Width	130mm / 5"	130mm / 5"	130mm / 5"
Length	1200mm / 47.2"	1200mm / 47.2"	1500mm / 59"
Weight	2.2lbs/1kg	2.2lbs/1kg	2.75lbs/1.13kg

### DAISY CHAIN

When using the iLW Dual/Tri/Quad Power Hubs for daisy chaining fixtures, the max load at 120V is 400W Power and at 277V is 800W power.

MODEL:	2.5	VOLTAGE:	120-277V	<b>3</b>
WATTS:	40W	SKU:	IL-4025FSG-120	
	60W		IL-6025FSG-120	
	80W		IL-8025FSG-120	



### ILW LED SPECTRUM

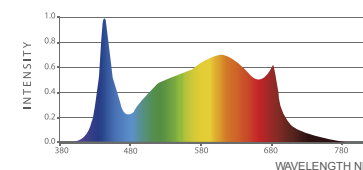

### MOUNTING & COVERAGE

#### ILW 40W & 60W

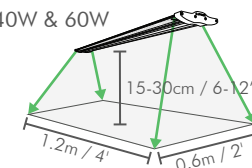

#### ILW 80W

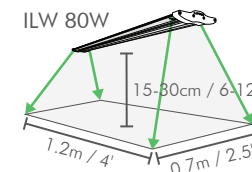

#### iLW 80W

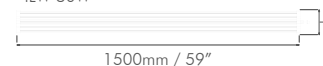

#### iLW 40W & 60W



# HARDWARE AND ACCESSORIES

The iLW LED fixture can be hung from steel cables or can be mounted to a rack.

Before you begin installation, check that you have all the necessary parts to begin.

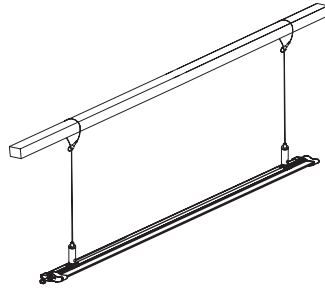

# IN THE BOX



1 iLW Fixture



1 Power Cable



2 Metal Clips for Hanging Cables



2 Screws for Clips & Hanging Cables



2 Steel Hanging Cables with Cylindrical Lock



4 Screws & 4 Anchors

# HANGING INSTALLATION

1

Loop the steel cables over the beam, feeding the wire through its loop and letting the cylindrical lock hang.

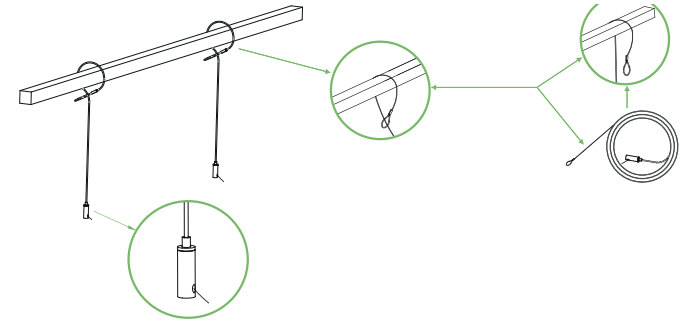

2

Using the provided screw, attach the clip to the steel cable's cylindrical lock.

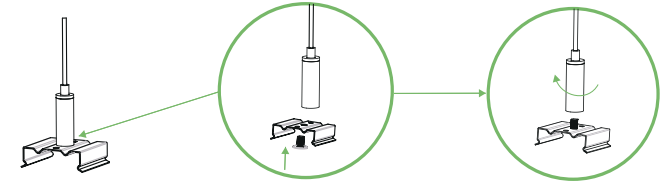

3

Snap the clips onto the light bar's heat sink.



(see next page...)

4

Adjust the spacing of the clips as needed.

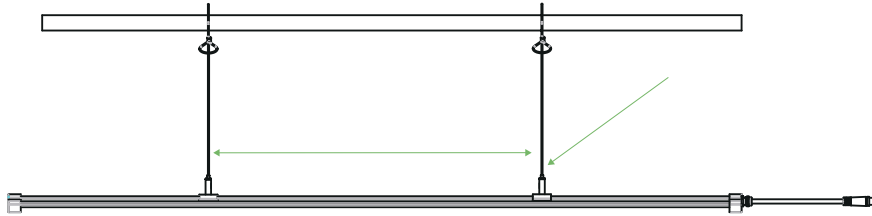

5

Pull the steel cable down through the cylindrical lock to adjust the fixture height.

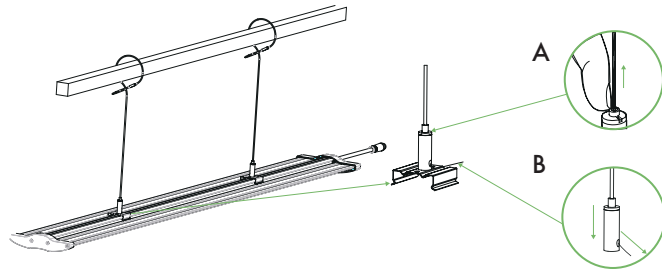

To shorten cable: Press the cable down through the cylindrical lock. (Figure A)  
To extend cable: Press metal top down and pull up on cable. (Figure B)

## MOUNTING INSTRUCTIONS

1

Drill 4 holes into an overhead structure or rack. Insert the provided mounting anchors into the holes and screw the metal clips directly into the anchors.

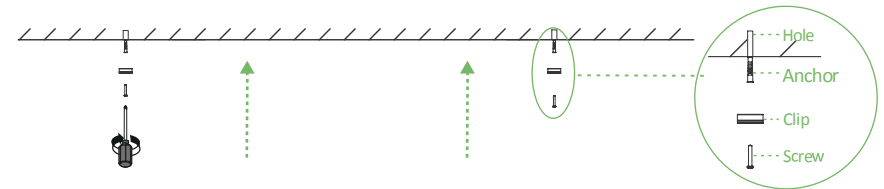

2

Snap the bar into the clips.

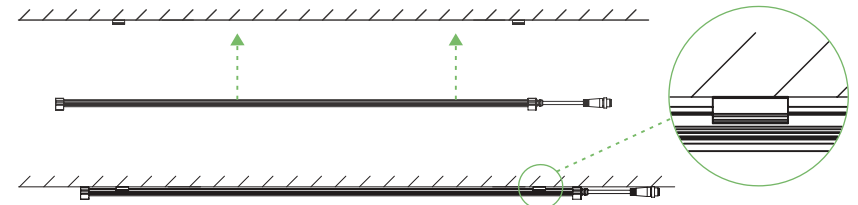

## ADDITIONAL ACCESSORIES

If you use more than one iLW in your grow room or clone rack, save space by adding in the iLW Power Hub. The hub comes as a dual, tri- or quad-connector that will send power to each of your iLW fixtures without the need of additional outlets.

When using the iLW Dual/Tri/Quad Power Hubs for daisy chaining fixtures, the max load at 120V is 400W Power and at 277V is 800W power.

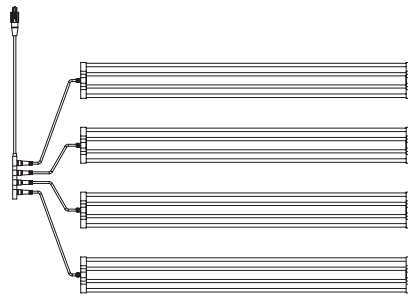

# PRECAUTIONS

Please read the following list carefully prior to beginning installation.

1. Leave at least one inch of space between the fixture and the mounting area for maximum performance and lifespan.
2. ALWAYS wear protective eyewear when looking directly at the diodes to prevent eye damage.
3. Only handle, clean or move fixture when it's unplugged and completely cool.
4. Keep the fixture free of dust, debris, and deposits to ensure the maximum potential of the fixture.
5. NEVER use a cloth to clean the diodes. This can scratch the diodes and could potentially break or dislodge them.
6. DO NOT use chemicals to clean the fixture. Use ONLY low pressure air or low pressure water to remove dust and debris.
7. DO NOT exceed 70% max load for breakers due to inrush current in LED fixtures

## 5 YEAR WARRANTY GUARANTEE

At ILUMINAR, we stand behind our products and our technology as well as our customers. All ILUMINAR LED fixtures are backed by our 5-Year Guarantee. Please visit our website [iluminarlighting.com/warranty](http://iluminarlighting.com/warranty) for more information.