

pH Balancer

Quick Start Guide

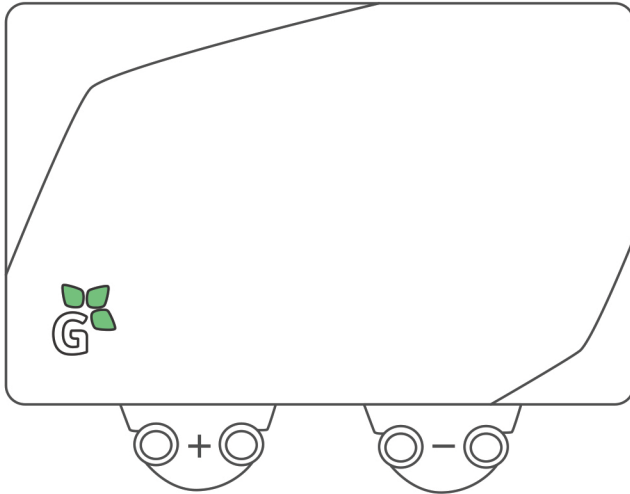

What's In The Box

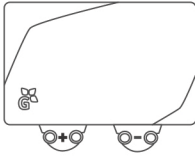

pH Balancer



Add-on Cable

Add more Nutrient Doser units and create your own tailored feeding solution automation

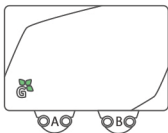

Nutrient Doser

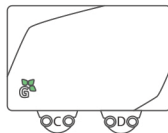

Nutrient Doser

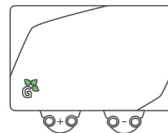

pH Balancer

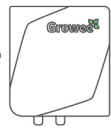

Hydro Master

Set Up Your pH Balancer

Step 1: Disconnect the Hydro Master from the power supply



Step 2: Install the pH Balancer on the wall

A. Place the pH Balancer on the left side of the Hydro Master or the Nutrient Doser, if already installed, at a maximum distance of 3.5 inches.

B. Use a 4/7 mm irrigation pipe for the pumps. The tube length must not exceed 23 inches.

C. Make sure the ends of the tubes can reach the tank and are well above the water level at all times. Avoid all contact between the tubes and the water in the tank.

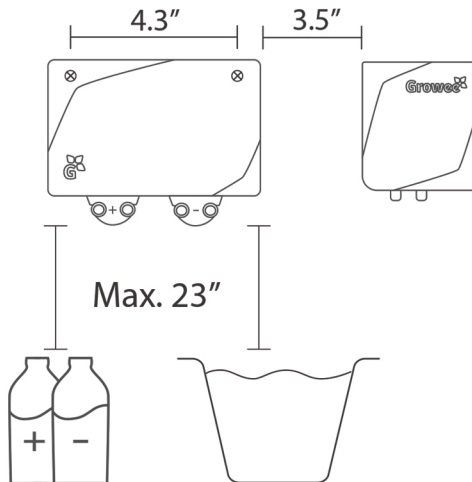

Step 3: Connect the pH Balancer to the Hydro Master

Important notice:

Before connecting the pH Balancer ensure that the Hydro Master is disconnected from the power source

A. Use the connecting cable to connect the pH Balancer to the Growee Hydro Master or Nutrient Doser, if already installed.

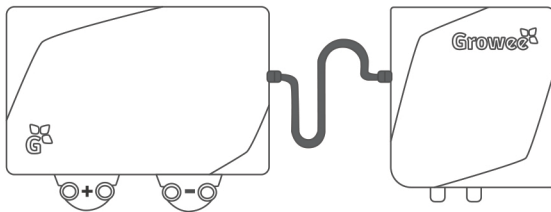

B. Connect the Hydro Master to the power supply and wait until the Growee Hydro Master indicator light is solid green. It should take up to 1 minute.

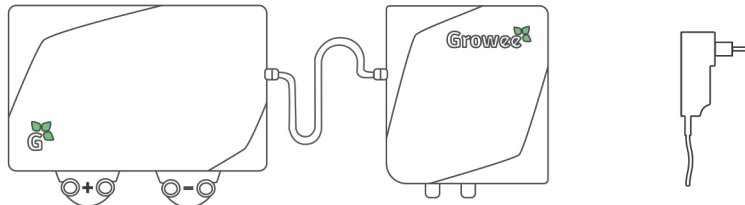

Step 4: Connect tubes to the pH Balancer pumps

Important notice:

- The pump marked + is designated for the pH up solution.
- The pump marked - is designated for the pH down solution.

A. Connect the pump fittings marked with ↑ to your preferred pH solution.

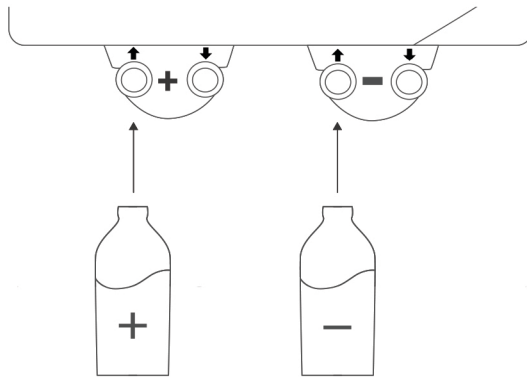

B. Connect the pump fittings marked with ↓ to the water tank. Make sure the ends of the tubes are above the tank water at all times. Avoid all contact between the tubes and the water in the tank.

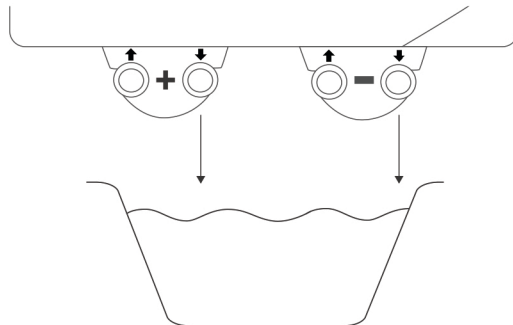

Step 5: Balance the pH level using the app

A. Go to www.MyGrowee.com or to your smartphone app and log in with your username and password.

B. On the main Dashboard, press on the "pH level" button.

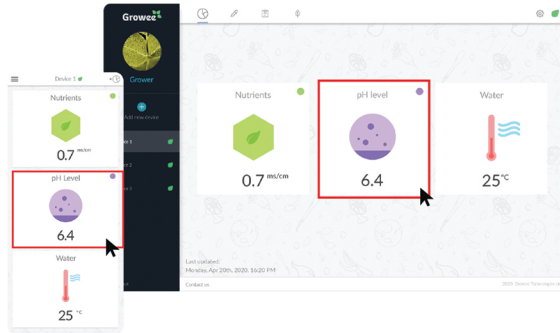

C. Choose the desired pH range and press start

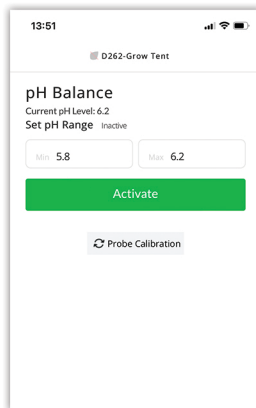

D. The pH Balancer will maintain the pH level within the defined range.



For support and instructional videos, visit our website:
www.GetGrowee.com

If you still need help, don't hesitate to contact us at
Contact@GetGrowee.com