

# Sun System® 1000 DE BOSS® COMMERCIAL FIXTURE

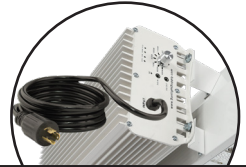

Sun System® 1 Ballasts are controller-compatible with signal ports for on / off / dimming functions (Eteelligent™ controller sold separately, Part # 902245)

**3 YEAR WARRANTY**  
-REPAIR OR REPLACE FIXTURE-  
Full warranty detail within.

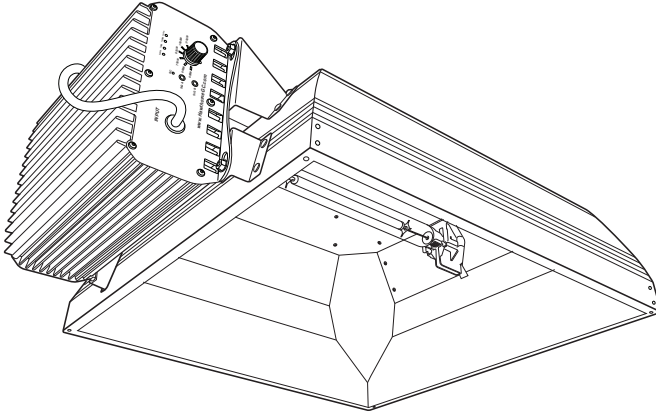

Includes hard-wired 277 volt power cord with a L7-15p 277 volt twist lock power plug.

## Installation & Operating Instructions

Product # 906612 Sun System® 1000 Watt DE Boss® Commercial Fixture 277 Volt

**READ THESE INSTRUCTIONS BEFORE FIRING UP YOUR BALLAST**

**KEEP ORIGINAL PACKAGING:** *All returns need to be in the original packaging in order to avoid product damage during shipping. Any damage to products not in their original packaging will not be covered under warranty.*

### SAFETY FIRST!

Failure to observe the following safety warnings may result in serious injury. In addition, failure to observe these safety warnings will result in a waiver of all liabilities and will void all warranties.

### WARNING:

- If the exterior of the lamp is damaged, replace lamp immediately.
- When relamping, make sure lamp has time to cool before touching.
- Make sure power cord is connected properly.
- Disconnect power before relamping.
- **DO NOT** hang by power or lamp cord.
- **DO NOT** make contact with the interior of the socket while power is on.
- **DO NOT** operate light systems in wet locations.
- **DO NOT** plug system into supply voltage other than what is designated on ballast.
- **DO NOT** attempt to rewire or reconfigure your system, it will void warranty and could cause serious safety hazards (i.e. power cord, lamp cord, lamp socket or ballast).

**Keep away from children.**

## SUN SYSTEM® 1000 WATT DE BOSS® COMMERCIAL FIXTURE SETUP:

1. Remove the system from the box along with all additional parts.
2. These systems do not require much setup.
3. Insert a DE lamp into a DE reflector. (FIG. 1) Insert each lamp wire of the double-ended lamp into both socket slots. Make sure the wires are straight. Push both ends of lamp firmly down into the metal clips. Slide each socket slider lock over both ends of the lamp to secure the lamp into place.
4. Hang the fixture using V-hangers provided (FIG. 3). Use an eye bolt or some other means of securely hanging from the ceiling. Sun Grip® Push Button Light Hangers (#710122, #710114, #710116 & #710123), (FIG. 2), Sky Hook™ Light Hangers (#710119) or jack chain (#350205) may be used to adjust the hanging height.
5. Plug the unit into the proper NEMA configured receptacle or hardwire unit depending on model voltage.

**FIG. 1**

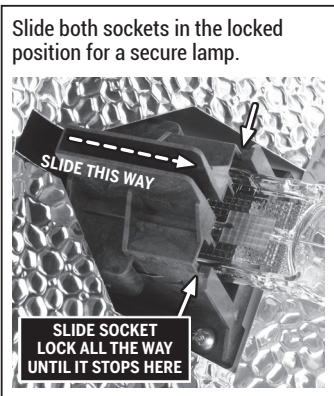
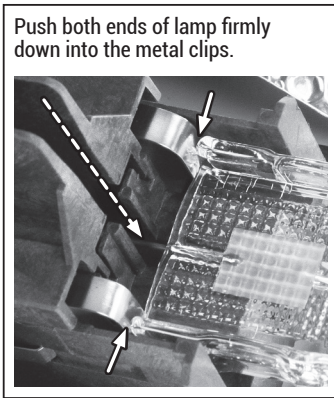

**FIG. 2**

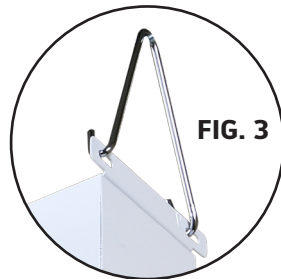

## SAFETY FIRST!

- **DO NOT** alter or modify this unit in any way. Unit may cause bodily injury or death as this is a high power electrical device.
- **DO NOT** submerge in water or splash water on the unit.
- **DO NOT** plug or unplug the lamp cord while the ballast is energized.

These high performance, ultra high frequency electronic ballasts are extremely efficient. They have a high power factor and high luminous efficacy. Their stable performance creates constant power output even when power fluctuates (power surge). Short circuit protection technology prevents damage to the lamp and other ballasts connected to the same circuit.

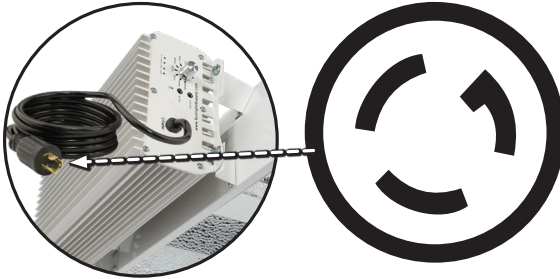

### **277 Volt Fixture:**

Includes 6 ft. hard-wired power cord with a L7-15p twist lock plug.

This 906612 Sun System® 1 DE BOSS® COM 1000 Watt 277 Volt fixture has a hard-wired 6 foot 277 Volt power cord with a L7-15p 277 Volt twist lock plug.

- 277 Volt
- Frequency: 50/60Hz
- Power Factor: > 0.99%
- Max Ambient Temp: 104°F
- Total Harmonic Distortion: (THD): < 10.0%

## NOTES

- This Sun System® 1000 WATT DE BOSS® COM Commercial Etelligent™ Electronic Ballast is designed to operate 1000 Watt double-ended H.I.D. lamps.
- This unit offers short-circuit and power fluctuation protection.
- Features internal built-in circuit breaker.

---

**WIRING - VERY IMPORTANT!** All digital ballasts may malfunction if the circuit has a neutral. The input for the ballast is 2 HOT WIRES and 1 GROUND WIRE. If you are using a light controller ONLY bring a ground wire and two hot leads from your electrical panels.

**HOT RESTRIKE** - The 1000 Watt DE Boss® COM features a hot restrike function to protect the lamp and ballast. This function allows the ballast to reignite the lamp once it has cooled. In the event of a power interruption or failed ignition, the ballast will wait one minute and attempt to restart the lamp. If the lamp does not ignite at that time, it will make four more attempts in five minute intervals. If the ballast has ran though the complete sequence (1 minute -5 minutes -5 minutes -5 minutes -5 minutes), the ballast will go into a locked mode. The ballast will not begin the ignition sequence again until it has been disconnected from power. This can be achieved by unplugging the ballast and plugging it back in or waiting until the next set timer cycle. Do not unplug the ballast until it has completed the full twenty-six minute sequence.

**LAMP REPLACEMENT** - Be sure to disconnect the power source before changing lamps. Always use the specified wattage lamp. (*ie: A 400 Watt halide lamp should NOT be used in a 600 Watt ballast*).

**TIMER BOX** - If you are connecting a 277 volt ballast to a timer box, please make sure that it cuts off both legs when timer is switched off. If you continue to supply voltage to your ballast when the timer is switched off, it may damage your ballast.

**LAMP RECOMMENDATIONS** - The ballasts are designed to provide superior performance with several lamps manufactured to American specifications. There are several brands of lamps available for the U.S. market that were made according to European specifications. We do not recommend using these types of lamps, since they will provide inconsistent performance with your ballast.

**ERROR CODES** - If the ballast encounters any abnormal conditions the built-in self-diagnostic feature will display easily identifiable error codes. Error codes can be identified by the number of flashes made by the green LED marked "turbo".

**1 Flash = Ballast Protection:** This code means that the ballast has gone into a locked mode to protect itself. This may be followed by another code to help troubleshoot the cause.

**2 Flash = Bad Lamp/Short Circuit:** This code means that the ballast has a bad connection somewhere between the ballast and lamp. Reasons can include a bad lamp, loose lamp, loose lamp cord, a short in the cord or reflector, or a short in the ballast receptacle.

**3 Flash = Low Voltage:** This code means the power coming from the outlet to your ballast is not sufficient to power the unit.

**4 Flash = Over Temperature:** This code means the ballast has shut itself off due to overheating (>140° F).

**5 Flash = Over Voltage:** This code means the power from the outlet to your ballast has exceeded the maximum allowed voltage.

**6 Flash = Lamp Fault:** Incorrect/non compatible lamp will not work with ballast.



**ETELLIGENT™**  
**CONTROLLER**  
*compatible*

**CONTROL UP TO 400 SUN SYSTEM DOUBLE-ENDED COMMERCIAL FIXTURES OR OTHER COMPATIBLE MODELS WITH ONE ETELLIGENT™ CONTROLLER!**

The Sun System® 1 Eteelligent™ digital lighting controller enables the grower to control up to 400 fixtures. Features an industry first, the ability to control any Sun System® Eteelligent™ compatible fixture or ballast with the same controller, operating on separate channels. This two channel controller allows daisy-chaining up to 200 fixtures per zone. Enabling complete control of your growing environment with timed on/off switching, sunrise/sunset, accurate temperature readings with dual thermal probes and thermal-threshold auto dim-shutdown for additional protection.

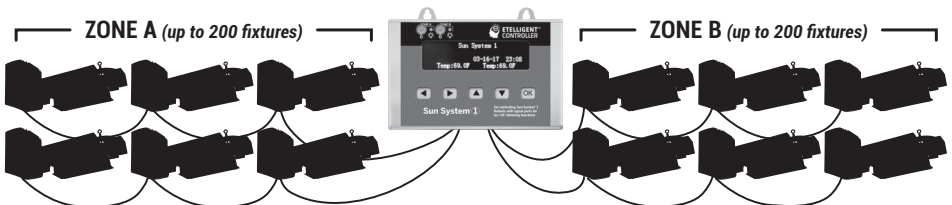

**Sun System® 1 Eteelligent™ Controller Kit #902245** (sold separately) allows wired control of the on/off/dimming capabilities. Complete kit includes: 1 Eteelligent™ Controller, 1 universal power adapter 5 ft/1.5 m cable, 2 each 16 ft/5 m signal wires with ferrites for connection from controller to ballast and 2 each 16 ft/5 m temperature probes.

## TROUBLESHOOTING GUIDE

Follow the troubleshooting tips below. If troubleshooting techniques fail, bring ballast back to your place of purchase to request warranty service.

POSSIBLE CAUSES	CORRECTIVE MAINTENANCE
<b>LAMP LOOSE IN SOCKETS</b>	Make sure that the lamp is fully inserted into the socket and that the socket is in the closed position.
<b>INCORRECT VOLTAGE</b>	Make sure you are using the correct input voltage with fixture. If using incorrect voltage, disconnect the fixture from the power source immediately.
<b>DEFECTIVE OR IMPROPER WIRING</b>	Examine wiring to ensure it agrees with wiring diagrams on fixture label. Check connections to see that they are secure. If wiring a 240 volt fixture, DO NOT use a neutral. The correct wiring is two hot wires and a ground.
<b>POOR ELECTRICAL CONNECTIONS</b>	Check wiring and lamp contact with socket. Make sure the lamp cord is firmly seated in output receptacle.
<b>INCORRECT LAMP</b>	Verify that you are using a 1000 Watt double-ended lamp.
<b>LAMP DAMAGE</b>	Investigate possibility of outer bulb damage. Look for broken tubes or loose metal parts. Replace lamp.

<b>FCC compliance</b>	This device complies with Part 18 of the FCC Rules.
<b>Advisory statement</b>	This product may cause interference to radio equipment and should not be installed near maritime safety communications equipment or other critical navigation or communication equipment operating between 0.45-30 MHz.
<b>The interference potential of the device or system</b>	The interference potential of the device or system is the operating frequency; 110 kHz.
<b>Maintenance of the system</b>	Unplug the unit, wait 30 seconds, and plug the unit back in.
<b>Simple measures that can be taken by the user to correct interference</b>	Move the unit away from any radio device.

- This product contains delicate electronic components. This means that if it is placed near an object that transmits radio signals, it could cause interference. This could be, for example, mobile telephones, walkie talkies, CB radios, remote controls and microwaves. If interference occurs, move such objects away from the appliance.

### Sun System® 1000 Watt DE Boss® Commercial Fixture:

Compliant with FCC Part 18 Class A (governs commercial use) and FCC Part 18 Class B (governs residential use) as tested by an independent US testing lab in a true as used configuration. In our case, Northwest EMC or ElectroMagnetic Investigations, Hillsboro OR.

**This installation guide does not supersede national, state, or local regulations for electrical installations.**

### TROUBLESHOOTING... IF YOUR FIXTURE DOES NOT WORK:

1. CHECK YOUR ELECTRICAL SOURCE: Make sure the unit is plugged in properly and that the breaker is not tripped or fuse blown.
2. CHECK THE LAMP COLOR: Make sure the lamp is fully seated in the socket.



## **WARRANTY SERVICE:**

### **PLEASE READ WARRANTY INFORMATION FIRST**

If the fixture does not work after troubleshooting, please return the fixture to the dealer where it was purchased. The dealer will evaluate and test the fixture and its components. The dealer may be able to repair the fixture on site. If the dealer is unable to repair the fixture, they will return it to us for factory repair. Many dealers will provide loaner fixtures for use during the repair period (usually not more than 7-10 days).

To locate dealers within the United States: [www.HawthorneGC.com](http://www.HawthorneGC.com). To locate dealers within Canada: [www.HawthorneGC.ca](http://www.HawthorneGC.ca) and click "AUTHORIZED DEALERS". If there are no dealers in your area, please contact us directly for technical support. If we cannot help you resolve the problem over the phone and if the unit is still in warranty, we will issue you an RMA # (return merchandise authorization number) authorizing you to return the fixture to us for factory reconditioning. You will be asked to provide an email address or fax number to receive the RMA form. The completed RMA form must be included in the packaging when returning your Sun System® fixture. Also please write the RMA # on the outside of the box.

### **Please package the fixture carefully in its original packaging. We are not responsible for fixtures damaged during shipment.**

The fixture will be repaired within 48 hours of receipt and returned via UPS Ground. If the fixture cannot be repaired, a replacement will be sent. If there are no identical fixtures available, a comparable fixture will be substituted.

# **IMPORTANT:**

## **PROOF OF PURCHASE REQUIRED FOR RETURNS**

**SUN SYSTEM® 1000 WATT DE BOSS® COMMERCIAL FIXTURE:  
3 Year Warranty Returning Units: *Please contact your retail store for returns.***

### **LIMITED WARRANTY:**

When purchased from an authorized Hawthorne dealer, this product is covered by a LIMITED WARRANTY available at [hawthornegc.com/warranties](http://hawthornegc.com/warranties). You can also obtain the Terms of Sale and Limited Warranty by calling Hawthorne toll free at 1-888-478-6544 or writing Hawthorne at: Hawthorne Hydroponics LLC, 3204 NW 38th Circle, Vancouver, WA 98660, Attn: Customer Service.



# NOTES

-----

-----

-----

-----

-----

-----

-----

-----

-----

-----

-----

-----

-----

-----

-----

-----

-----

-----

-----

-----

-----

-----

-----

-----



---

**HAWTHORNE GARDENING™**

CO

---

Manufactured for Hawthorne Hydroponics LCC,  
a subsidiary of The Hawthorne Gardening Company  
3204 NW 38th Circle, Vancouver, WA 98660

HawthorneGC.com | HawthorneGC.ca

©2019. World rights reserved.