

ALUMINUM

# TWISTER

## TRAYS & RACKS

### ASSEMBLY INSTRUCTIONS

PN: 21-10147A\_REV02 (Instructions)

PN: 25-0027-00-20-P\_REV01 (Rack and Trays)

### Completed Assembly



### Parts



### Tools Needed

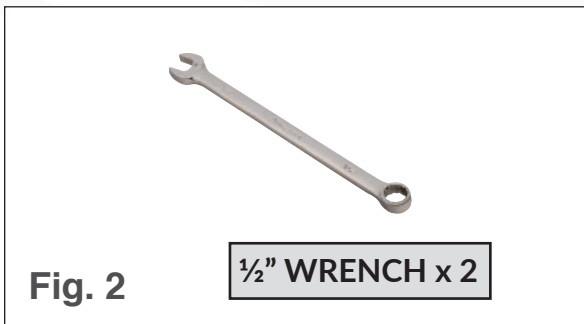

For additional assistance with assembly, Keirton Technical Support is available between 7 a.m. and 7 p.m. Pacific Standard Time, seven days a week at:

- 1-888-254-3204
- [support@keirton.com](mailto:support@keirton.com)

## Step 1: Attach the Cross Bars to One of the Racks

1. Place one of the racks on its side on the floor (see Fig. 4).
2. Place a bolt through a split washer, then a c-bracket, then a bolt hole in one of the rack's three horizontal cross bars (see Fig. 5). Place the bolt through the rack's flat side so it comes out on the same side as the tray supports.
3. Align a bolt hole in a cross brace with the bolt (see Fig. 5), and thread the bolt into it. **Do not fully tighten the bolt.**
4. Repeat steps 2 and 3 on the second bolt hole.
5. Tighten both bolts to secure the cross brace to the rack.
6. Repeat steps 2-5 with the remaining two cross braces (see Fig. 6).

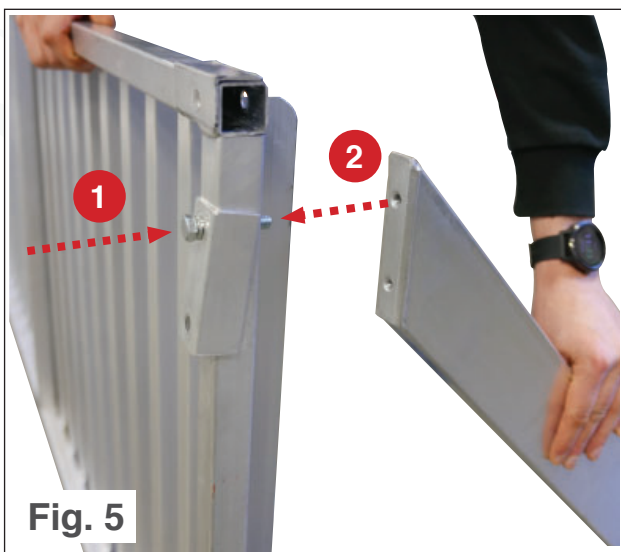
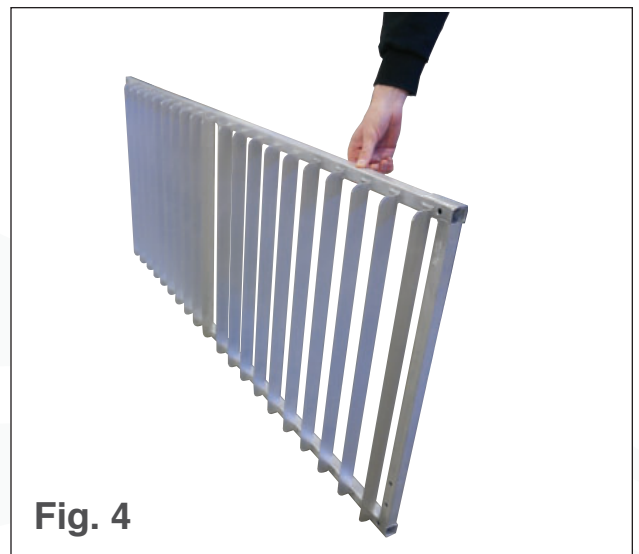

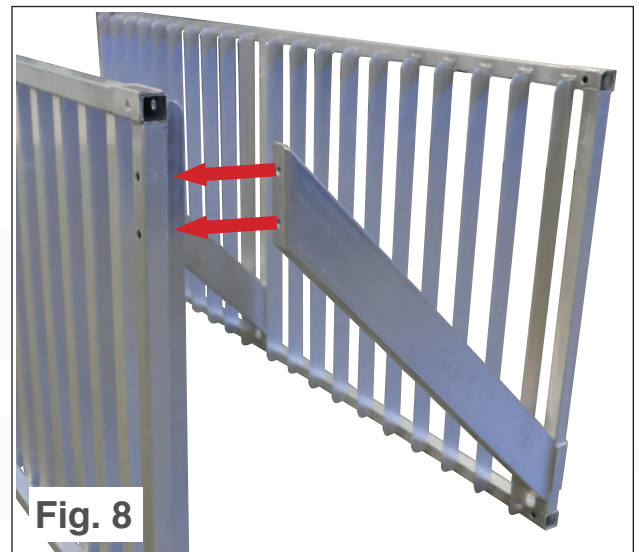
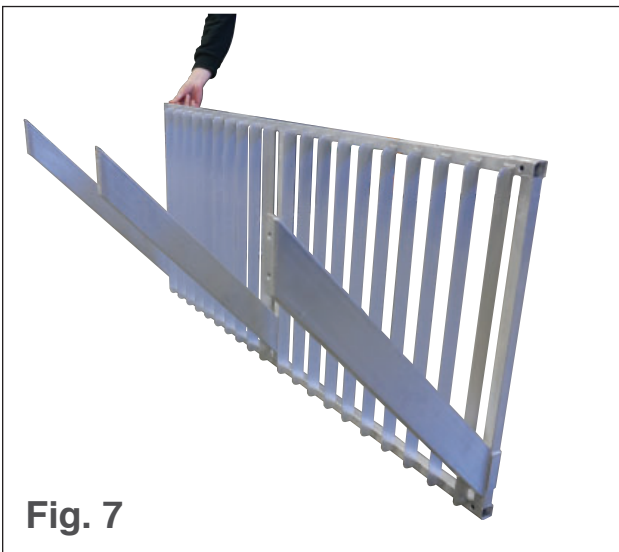

## Step 2: Attach the Second Rack

1. Rotate the partially assembled rack 180° so it rests on its side with the cross bars pointing up and out (see Fig. 7).
2. Align the bolt holes in the unattached rack with the free ends of the cross braces (see Fig. 8). Ensure the unattached rack's tray supports are protruding out towards the attached rack.
3. Place a bolt through a split washer, then a c-brace, then a cross bar bolt hole in the unattached rack, and thread into one of the cross braces (see Fig. 9). **Do not fully tighten the bolt.**
4. Repeat step 3 on the remaining five cross bar bolt holes.
5. Tighten all six bolts attaching the second rack to the cross braces.

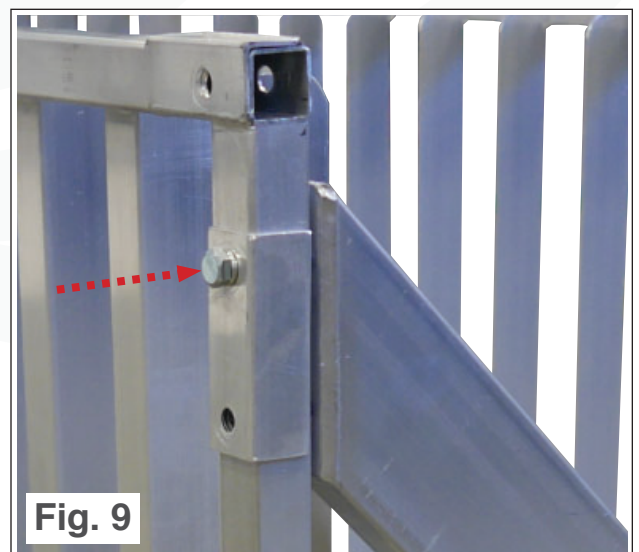

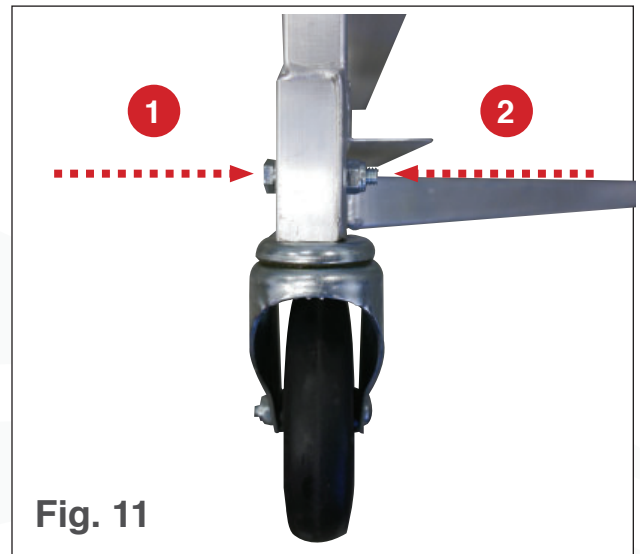

## Step 3: Attach the Casters and Insert Trays

1. Ensure the rack is oriented on the floor as shown in Fig. 10.
2. Insert the two locking casters into the two rack slots closest to the floor. Ensure the bolt hole in each caster aligns with the bolt holes in the bottom of the racks.
3. Insert the two regular casters into the two remaining rack slots. Ensure the two regular casters are directly opposite each other and not diagonal.
4. Place a bolt through a split washer, then through a bolt hole in the bottom of the racks and casters (see Fig. 11).
5. Secure a nut over the end of the bolt (see Fig. 11).
6. Repeat steps 4 and 5 on the remaining three casters.
7. Stand the rack upright and insert the trays.
8. Place the metal sheet in the bottom tray to catch any debris (see Fig. 12).

