

DEHUMIDIFIER

Owner's Manual & Installation Manual



IMPORTANT NOTE:

Read this manual carefully before installing or operating your new machine.
Make sure to save this manual for future reference.

Table of Contents

Safety Precautions

Safety Precautions	03
--------------------------	----

Preparation

Identification of parts.....	06
Design Notice.....	06
Positioning the unit.....	07
When using the unit.....	07
Accessories.....	07

Operating Instructions

Control Panel Features.....	08
Other features.....	09
Removing the collected water.....	10

Care and Maintenance

Clean the grille and case.....	12
Clean the bucket	12
Clean the air filter	12
When not using the unit for long time periods	12

Troubleshooting Tips

Troubleshooting Tips	13
----------------------------	----

Safety Precautions

Read Safety Precautions Before Operation and Installation

To prevent death or injury to the user or other people and property damage, the following instructions must be followed. Incorrect operation due to ignoring of instructions may cause death, harm or damage.



WARNING

This symbol indicates the possibility of personnel injury or loss of life.



CAUTION

This symbol indicates the possibility of property damage or serious consequences.



WARNING

- Do not exceed the rating of the power outlet or connection device.
- Do not operate or stop the unit by switching on or off the power.
- Do not damage or use an unspecified power cord.
- Do not modify power cord length or share the outlet with other appliances.
- Do not insert or pull out plug with wet hands.
- Do not install the appliance in a location that may be exposed to combustible gas.
- Do not place the unit near a heat source.
- Disconnect the power if strange sounds, smell, or smoke comes from it.
- You should never try to take apart or repair the unit by yourself.
- Before cleaning, turn off the power and unplug the unit.
- Do not use the machine near flammable gas or combustibles, such as gasoline, benzene, thinner, etc.
- Do not drink or use the water drained from the unit.
- Do not take the water bucket out during operation.
- Do not use the unit in small spaces.
- Do not put in places where water may splash onto the unit.
- Place the unit on a level, sturdy section of the floor.
- Do not cover the intake or exhaust openings with cloths or towels.
- Care should be taken when using the unit in a room with the following persons: infants, children, elderly people, and people not sensitive to humidity.
- Do not use in areas where chemicals are handled.
- Never insert your finger or other foreign objects into grills or openings. Take special care to warn children of these dangers.
- Do not place heavy object on the power cord and take care so that the cord is not compressed.
- Do not climb up on or sit on the unit.
- Always insert the filters securely. Clean filter once every two weeks.
- If water enters the unit, turn the unit off and disconnect the power, contact a qualified service technician.
- Do not place flower vases or other water container on top of the unit.
- Do not use extension cords.



CAUTION

- This appliance can be used by children aged from 8 years and above and person with reduced physical, sensory or mental capabilities or lack of experience and knowledge if they have been given supervision or instruction concerning use of the appliance in a safe way and understand the hazards involved. Children shall not play with the appliance. Cleaning and user maintenance shall not be made by children without supervision. (be applicable for the European Countries)
- This appliance is not intended for use by persons (including children) with reduced physical, sensory or mental capabilities or lack of experience and knowledge, unless they have been given supervision or instruction concerning use of the appliance by a person responsible for their safety. Children should be supervised to ensure that they do not play with the appliance. (be applicable for other countries except the European Countries)
- If the supply cord is damaged, it must be replaced by the manufacturer, its service agent or similarly qualified persons in order to avoid a hazard.
- Prior to cleaning or other maintenance, the appliance must be disconnected from the supply mains.
- Do not install the appliance in a location that may be exposed to combustible gas. If combustible gas accumulates around the unit, it may cause fire.
- If the appliance is knocked over during use, turn off the unit and unplug it from the main power supply immediately. Visually inspect the unit to ensure there is no damage. If you suspect the unit has been damaged, contact a technician or customer service for assistance.
- In a thunderstorm, the power must be cut off to avoid damage to the machine due to lightning.
- Do not run cord under carpeting. Do not cover cord with throw rugs, runners, or similar coverings. Do not route cord under furniture or appliances. Arrange cord away from traffic area and where it will not be tripped over.
- Do not operate unit with a damaged cord or plug. Discard unit or return to an authorized service facility for examination and/or repair.
- To reduce the risk of fire or electric shock, do not use this fan with any solid-state speed control device.
- The appliance shall be installed in accordance with national wiring regulations.
- Contact the authorised service technician for repair or maintenance of this unit.
- Turn off the product when not in use.
- The manufacturer's nameplate is located on the rear panel of the unit and contains electrical and other technical data specific to this unit.
- Be sure the unit is properly grounded. To minimize shock and fire hazards, proper grounding is important. The power cord is equipped with a three-prong grounding plug for protection against shock hazards.
- Your unit must be used in a properly grounded wall receptacle. If the wall receptacle you intend to use is not adequately grounded or protected by a time delay fuse or circuit breaker (please refer to the nameplate for the electrical data), have a qualified electrician install the proper receptacle.
- Do not operate your air conditioner in a wet room such as a bathroom or laundry room.
- The unit's circuit board (PCB) is designed with a fuse to provide overcurrent protection. The specifications of the fuse are printed on the circuit board, such as: T3.15A/250V (or 350V), etc.

Note about Fluorinated Gasses(Not applicable to the unit using R290 Refrigerant)

1. Fluorinated greenhouse gases are contained in hermetically sealed equipment. For specific information on the type, the amount and the CO₂ equivalent in tonnes of the fluorinated greenhouse gas(on some models), please refer to the relevant label on the unit itself.
2. Installation, service, maintenance and repair of this unit must be performed by a certified technician.
3. Product uninstallation and recycling must be performed by a certified technician.

Sociable Remark

When using this dehumidifier in the European countries, the following information must be followed:

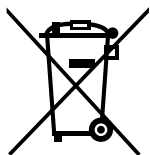

DISPOSAL: Do not dispose this product as unsorted municipal waste. Collection of such waste separately for special treatment is necessary.

It is prohibited to dispose of this appliance in domestic household waste.

For disposal, there are several possibilities:

- The municipality has established collection systems, where electronic waste can be disposed of at least free of charge to the user.
- When buying a new product, the retailer will take back the old product at least free of charge.
- The manufacture will take back the old appliance for disposal at least free of charge to the user.
- As old products contain valuable resources, they can be sold to scrap metal dealers. Wild disposal of waste in forests and landscapes endangers your health when hazardous substances leak into the ground-water and find their way into the food chain.

Preparation

Identification of parts

NOTE:

All the illustrations in the manual are for explanation purpose only. Your machine may be slightly different. The actual shape shall prevail. The unit can be controlled by the unit control panel alone or with the remote controller. This manual does not include Remote Controller Operations, see the <<Remote Controller Instruction>> packed with the unit for details.

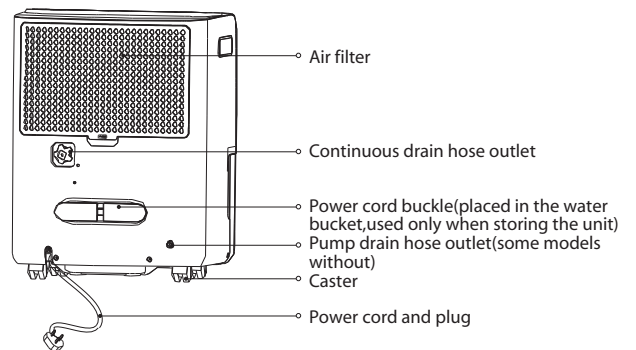
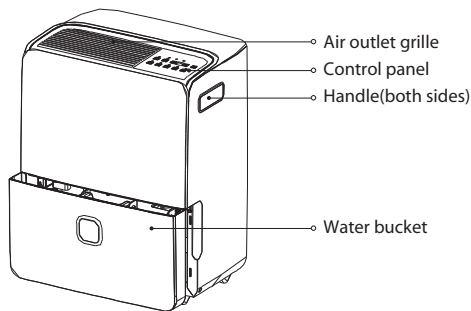
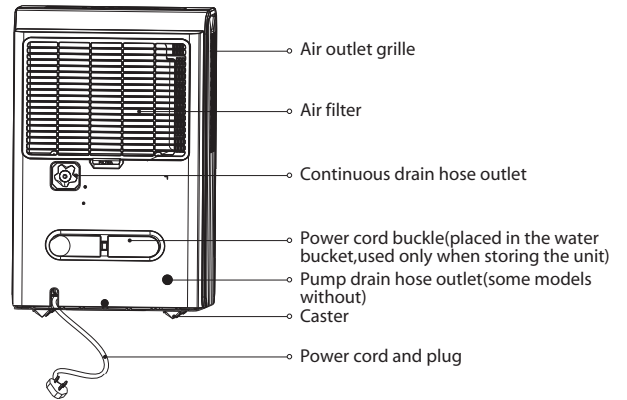
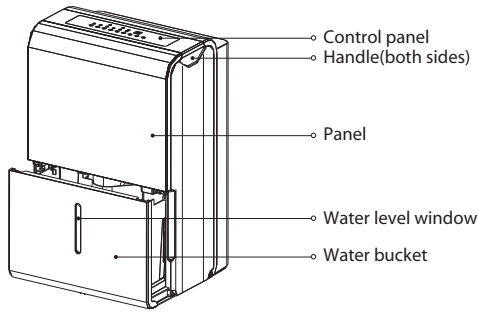

Design Notice

In order to ensure the optimal performance of our products, the design specifications of the unit are subject to change without prior notice.

Positioning the unit

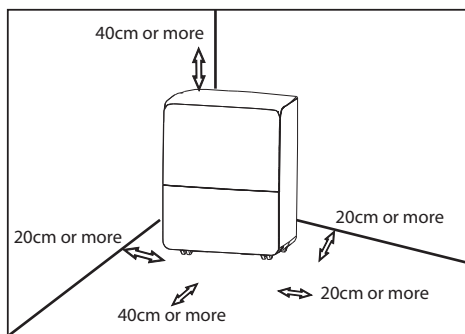

Casters (At four points on the bottom of unit)

- Casters can move freely.
- Do not force casters to move over carpet, nor move the unit with water in the bucket. (The unit may tip over and spill water.)

A dehumidifier operating in a basement will have little or no effect in drying an adjacent enclosed storage area, such as a closet, unless there is adequate circulation of air in and out of the area.

- Do not use outdoors.
- This dehumidifier is intended for indoor residential

applications only. This dehumidifier should not be used for commercial or industrial applications.

- Place the dehumidifier on a smooth, level floor strong enough to support the unit with a full bucket of water.
- Allow at least 20cm of air space on all sides of the unit for good air circulation (at least 40cm of air space on air outlet).
- Place the unit in an area where the temperature will not fall below 5°C(41°F). The coils can become covered with frost at temperatures below 5°C(41°F), which may reduce performance.
- Place the unit away from the clothes dryer, heater or radiator.
- Use the unit to prevent moisture damage anywhere books or valuables are stored.
- Use the dehumidifier in a basement to help prevent moisture damage.
- The dehumidifier must be operated in an enclosed area to be most effective.
- Close all doors, windows and other outside openings to the room.

When using the unit

- When first using the dehumidifier, operate the unit continuously 24 hours. Make sure the plastic cover on the continuous drain hose outlet install stightly properly so there are no leaks.
- This unit is designed to operate with a working environment between tween°5 C/41°F and 32°C/90°F, and between 30%(RH) and 80%(RH).
- If the unit has been switched off and needs to be switched on again quickly, allow approximately three minutes for the correct operation to resume.
- Do not connect the dehumidifier to a multiple socket

outlet, which is also being used for other electrical appliances.

- Select a suitable location, making sure you have easy access to an electrical outlet.
- Plug the unit into a electrical socket-outlet with earth connection.
- Make sure the Water bucket is correctly fitted otherwise the unit will not operate properly.

Note:When the water in the bucket reaches to a certain level,please be careful to move the machine to avoid it falling down.

Accessories(placed in the bucket of the unit)

pump drain hose(1 pc)(only for the unit with pump feature)



female threaded end(1 pc)(on some models)



power cord bucket(1 pc)



installation of the power cord bucket

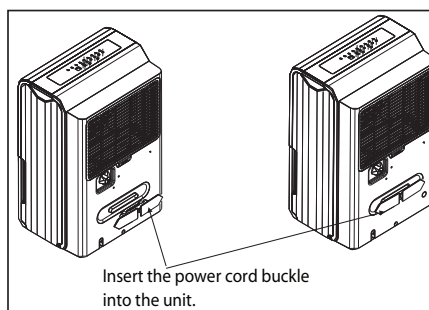

Operating Instructions

Control Panel Features

Note: The following control panels are for explanation purpose only. The control panel of the unit you purchased may be slightly different according to the models. Your machine may not contain some indicators or buttons. The actual shape shall prevail.

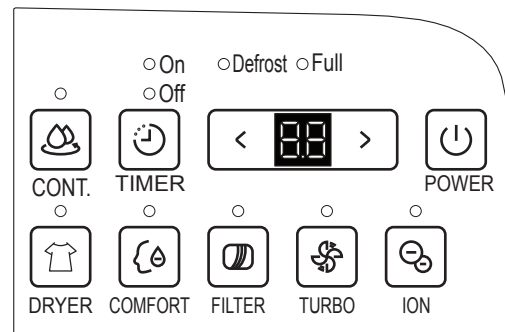
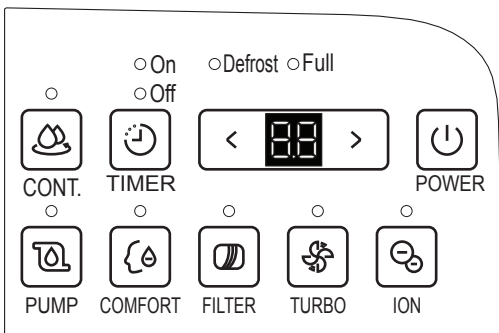
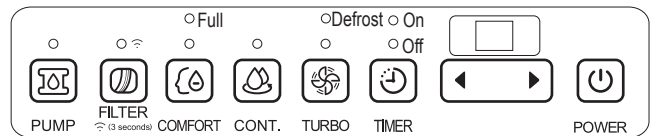
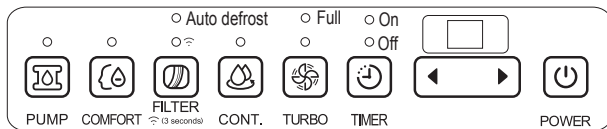
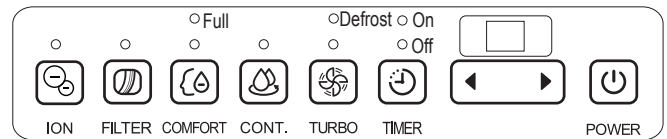
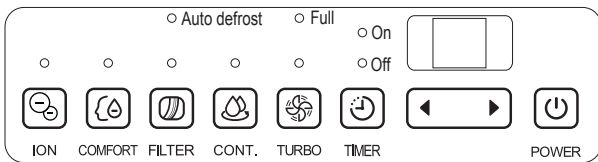

FILTER /WIRELESS(on some models) button

The check filter feature is a reminder to clean the Air Filter for more efficient operation. The Filter light (Clean filter light) will illuminate after 250 hours of operation. To reset after cleaning the filter, press the Filter button and the light will go off. Press the filter button for 3 seconds when the unit is on or off to initiate the Wireless connection mode. The LED DISPLAY shows 'AP' to indicate you can set Wireless connection and the compressor is forced off. If connection (router) is successful within 8 minutes, the unit will exit Wireless connection mode automatically and the Wireless indicator illuminates and the compressor reverts previous state. If connection is failure within 8 minutes, the unit exits the Wireless connection mode automatically.

TURBO Pad

Control the fan speed. Press to select either High or Normal fan speed. Set the fan control to High for maximum moisture removal. When the humidity has been reduced and quiet operation is preferred, set the fan control to Normal.

CONTINUE button

Press to activate the continuous dehumidifying operation.

Timer button

Press to initiate the Auto start and Auto stop feature, in conjunction with the ◀ and ▶ (or < and >) buttons.

UP/DOWN buttons

· Humidity Set Control buttons

The humidity level can be set within a range of 35% RH(Relative Humidity) to 85%RH(Relative Humidity) in 5% increments. For drier air , press the ◀ (or <) button and set to a lower percent value(%). For damper air, press the ▶ (or >) button and set a higher percent value(%).

· TIMER Set Control buttons

Use the Up/Down buttons to set the Auto start and Auto stop time from 0.0 to 24.

POWER button

Press to turn the dehumidifier on and off.

PUMP button(on some models)

Press to activate the pump operation.

Note: Make sure the pump drain hose is installed into the unit and the continuous drain hose is removed from the unit before the pump operation is activated. When the bucket is full,the pump starts to work.Refer to the next pages for removing the collected water. Do not use this operation when the outdoor temperature is equal to or less than 0°C (32°F).

COMFORT button(on some models)

Press to starts/stops the comfort dehumidifying operation.

Note: On this operation,the unit can not be set humidity level. For some models, under comfort dehumidifying operation, press Up/Down button will cancel this feature.

ION button(on some models)

Press to activate the ionizer. Anions are automatically generated by ionization. The anions deactivate the

airborne chemical vapors and dust particles. Press it again to stop the function.

DRYER button(on some models)

Press to activate the dryer operation. Press it again to stop the function.

Display

Shows the set % humidity level from 35% to 85% or auto start/stop time (0~24) while setting, then shows the actual(±5% accuracy) room % humidity level in a range of 30% RH(Relative Humidity) to 90%RH(Relative Humidity).

Error Codes and Protection Code:

AS-Humidity sensor error--Unplug the unit and plug it back in. If error repeats, call for service.

ES-Tube Temperature sensor of the evaporator error-- Unplug the unit and plug it back in. If error repeats, call for service.

P2-Bucket is full or bucket is not in right position-- Empty the bucket and replace it in the right position.(only available for the unit with no pump feature.)

P2-Bucket is full -- Empty the bucket.(only available for the unit with pump feature.)

Eb-Bucket is removed or not in right position-- Replace the bucket in the right position.(only available for the unit with pump feature.)

Note: When one of the above malfunctions occurs, turn off the unit, and check for any obstructions.

Restart the unit, if the malfunction is still present, turn off the unit and unplug the power cord. Contact the manufacturer or its service agents or a similar qualified person for service.

Other features

Bucket Full Light

Glows when the bucket is ready to be emptied.

Auto Defrost

When frost builds up on the evaporator coils, the compressor will cycle off and the fan will continue to run until the frost disappears.

Auto Shut Off

The dehumidifier shuts off when the bucket is full, or when the bucket is removed or not replaced in the

proper position.

For some models, the fan motor will continue to run for 30 seconds.

Wait 3 minutes before resuming operation

After the unit has stopped, it can not be restart operation in the first 3 minutes.This is to protect the unit. Operation will automatically start after 3 minutes.

Check filter feature

The system starts to count the time once the fan motor operates. The check filter feature can be only activated when the accumulated operation time achieves 250 hours or more. The Reset light (Clean filter indicator light) flashes at one time per second, after finishing clean the air filter, press the Filter button and the Reset light (Clean filter indicator light) goes off.

Auto-Restart

If the unit breaks off unexpectedly due to the power cut, it will restart with the previous function setting automatically when the power resumes.

Setting the Timer

- When the unit is on, first press the Timer button, the Timer Off indicator light illuminates. It indicates the Auto Stop program is initiated. Press it again the Timer On indicator light illuminates. It indicates the Auto Start is initiated.
- When the unit is off, first press the Timer button, the

Timer On indicator light illuminates. It indicates the Auto Start program is initiated. Press it again the Timer Off indicator light illuminates. It indicates the Auto Stop is initiated.

- Press or hold the UP or DOWN button to change the Auto time by 0.5hour increments, up to 10 hours, then at 1 hour increments up to 24 hours. The control will count down the time remaining until start.
- The selected time will register in 5 seconds and the system will automatically revert back to display the previous humidity setting.
- When the Auto Start & Auto Stop times are set, within the same program sequence, Timer On Off indicator lights illuminate identifying both On and Off times are now programmed.
- Turning the unit On or Off at any time or adjusting the timer setting to 0.0 will cancel the Auto Start/ Stop function.
- When LED display window displays the code of P2, the Auto Start/Stop function will also be cancelled.

Removing the collected water

There are three ways to remove collected water.

1. Use the bucket

- When the unit is off, if the bucket is full, the Full indicator light will light.
- When the unit is on, if the bucket is full, the compressor and the fan turn off, and the Full indicator light will light, the digital display shows P2.
- Slowly pull out the bucket. Grip the left and right handles securely, and carefully pull out straight so water does not spill. Do not put the bucket on the floor because the bottom of the bucket is uneven. Otherwise the bucket will fall and cause the water to spill.
- Throw away the water and replace the bucket. The bucket must be in right place and securely seated for the dehumidifier to operate.
- The machine will re-start when the bucket is restored in its correct position.

1. Pull out the bucket a little.

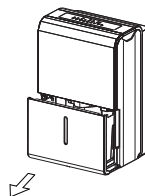

2. Hold both sides of the bucket with even strength, and pull it out from the unit.

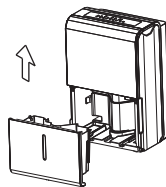

3. Pour the water out.

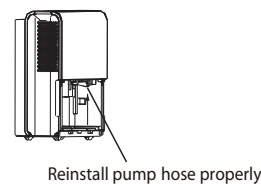
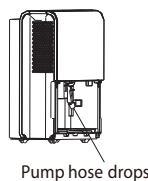

Notes:

- When you remove the bucket, do not touch any parts inside of the unit. Doing so may damage the product.
- Be sure to push the bucket gently all the way into the unit. Banging the bucket against anything or failing to push it in securely may cause the unit not to operate.
- If the pump hose drops when you remove the bucket, you must reinstall the pump hose properly to the unit before replace the bucket into the unit.
- When you remove the bucket,if there is some water in the unit you must dry it.
- When the unit is on, if the bucket is removed, the compressor and the fan turn off, then the unit will beep 8 times and the digital display shows Eb.
- When the unit is off, if the bucket is removed, the unit will beep 8 times and the digital display shows Eb.

2. Continuous draining

- Water can be automatically emptied into a floor drain by attaching the unit with a water hose (ID \geq Φ 5/16", not included) with a female threaded end (ID:M=1", not included)

Note: On some models, the female threaded end is include.

- Remove the plastic cover from the back drain outlet of the unit and set aside, then insert the drain hose through the drain outlet of the unit and lead the drain hose to the floor drain or a suitable drainage facility.

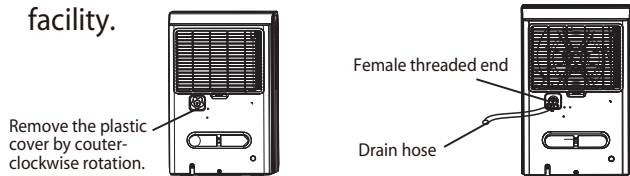

- When you remove the plastic cover, if there is some water in the back drain outlet of the unit you must dry it. Make sure the hose is secure so there are no leaks and the end of the hose is level or down to let the water flow smoothly.
- Direct the hose toward the drain, making sure that there are no kinks that will stop the water flowing. Make sure the water hose is lower than the drain hose outlet of the unit.
- Select the desired humidity setting and fan speed on the unit for continuous draining to start.

Note: When the continuous draining feature is not being used, remove the drain hose from the outlet, and dry the water in the continuous drain hose outlet.

3. Pump draining (on some models)

- Water can be automatically emptied into a floor drain or a suitable drainage facility by attaching the pump drain outlet with a pump drain hose(Φ od=1/4", supplied).
- Remove the continuous drain hose from the unit and install the plastic cover to the continuous drain hose outlet of the unit by clockwise rotation.
- Resert the pump drain hose into the pump drain hose outlet for depth of 15mm at least, then lead the water hose to the floor drain or a suitable drainage facility.

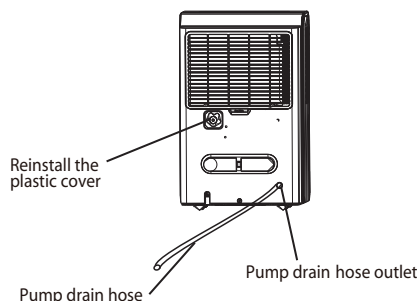

- Press the pump pad of the unit to activated the pump operation. When the bucket is full the pump starts to work.

Note: The pump may cause big noise when it starts to work for 3~5 minutes. It is a normal phenomenon.

- Make sure the hose is secure so there are no leaks.
- Direct the hose toward the drain, making sure that there are no kinks that will stop the water flowing.
- Place the end of the hose into the drain and make sure the end of the hose is level or down to let the water flow smoothly. Do never let it up.
- select the desired humidity setting and fan speed on the unit for pump draining to start.

Note: The pump operation on light blinks at 1Hz when the pump is operational failure. Please turn off the unit and plug the power cord out. Check the following things:

- Cleaning the filter of the pump.
 - Remove the bucket from the unit, take down the pump and clean the filter of the pump.

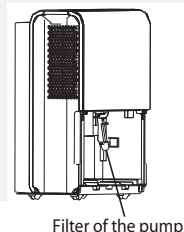

- Check that the pump drain hose does not link or back.
- Empty the water of the bucket.
- Reinstall the pump hose if it drops and reinstall the bucket properly. Turn on the unit. If the error repeats, call for service.

Note: Do not use this operation when the outdoor temperature is equal to or less than 0°C (32°F),

otherwise water is become ice that will cause the water hose blocked up and the unit failure. Make sure to empty the bucket once a week when using the pump draining feature. When the pump draining feature is not being used, remove the pump drain hose from the outlet.

- Press the pump drain hose outlet in and take the pump drain hose out from it (See Fig.13). Make sure do not let the water in the pump hose drip to the floor.

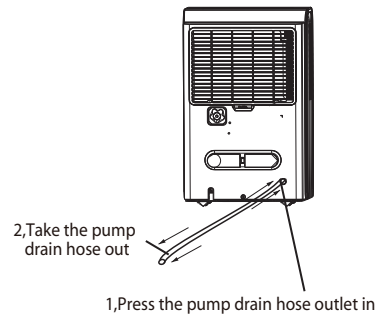

Care and Maintenance

Care and cleaning of the dehumidifier

Turn the dehumidifier off and remove the plug from the wall outlet before cleaning.

Clean the Grille and Case

- Use water and a mild detergent. Do not use bleach or abrasives.
- Do not splash water directly onto the main unit. Doing so may cause an electrical shock, cause the insulation to deteriorate, or cause the unit to rust.
- The air intake and outlet grilles get soiled easily, so use a vacuum attachment or brush to clean.

Clean the bucket

Every few weeks, clean the bucket to prevent growth of mold, mildew and bacteria. Partially fill the bucket with clean water and add a little mild detergent. Swish it around in the bucket, empty and rinse.

Note: Do not use a dishwasher to clean the bucket. After clean, the bucket must be in place and securely seated for the dehumidifier to operate.

Clean the air filter

- Remove the filter every two weeks based on normal operating conditions.
- To remove the filter, pull filter outwards.
- Wash the filter with clean water then dry.
- Re-install the filter, replace Bucket.



CAUTION

DO NOT operate the dehumidifier without a filter because dirt and lint will clog it and reduce performance.

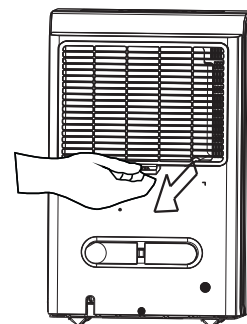

When not using the unit for long time periods

- After turning off the unit, wait one day before emptying the bucket.
- Clean the main unit, water bucket and air filter.
- Wrap the cord with the power cord buckle.
- Cover the unit with a plastic bag.
- Store the unit upright in a dry, well-ventilated place.

Troubleshooting Tips

Before calling for service, review the chart below first yourself.

Problem	What to check
Unit does not start	<ul style="list-style-type: none"> · Make sure the dehumidifier's plug is pushed completely into the outlet. · Check the house fuse/circuit breaker box. · Dehumidifier has reached its preset level or bucket is full. · Water bucket is not in the proper position.
Dehumidifier does not dry the air as it should	<ul style="list-style-type: none"> · Did not allow enough time to remove the moisture. · Make sure there are no curtains, blinds or furniture blocking the front or back of the dehumidifier. · The humidity control may not be set low enough. · Check that all doors, windows and other openings are securely closed. · Room temperature is too low, below 5°C(41°F). · There is a kerosene heater or something giving off water vapor in the room.
The unit makes a loud noise when operating	<ul style="list-style-type: none"> · The air filter is clogged. · The unit is tilted instead of upright as it should be. · The floor surface is not level.
Frost appears on the coils	<ul style="list-style-type: none"> · This is normal. The dehumidifier has Auto defrost feature.
Water on floor	<ul style="list-style-type: none"> · Hose to connector or hose connection may be loose. · Intend to use the bucket to collect water, but the back drain plug is removed.
ES, AS,P2,Eb appear in the display	<ul style="list-style-type: none"> · These are error codes and protection codes. See the CONTROL PANEL FEATURES section.
The pump operation on light blinks at 1Hz	<ul style="list-style-type: none"> · Clean the filter of the pump. · Check the pump hose does not link or block. · Empty the water of the bucket.

The design and specifications are subject to change without prior notice for product improvement. Consult with the sales agency or manufacturer for details. Any updates to the manual will be uploaded to the service website, please check for the latest version.